

DS300

Noise dosimeter



Table of contents

1 Introduction.....	5
1.1 Presentation.....	5
1.2 Main features.....	5
2 General points.....	6
2.1 Regulatory.....	6
2.2 Labour law.....	6
2.3 Measurement.....	6
2.4 Noise exposure – Exposure points.....	6
3 Vocabulary.....	7
4 Operating principle.....	8
4.1 Keyboard presentation.....	8
4.2 Screen presentation.....	8
5 Set the instrument.....	9
5.1 Adjust the contrast / backlight.....	9
5.2 Measurement programming.....	9
5.3 Reading.....	10
5.4 PC.....	10
5.5 Configuration.....	10
5.6 Battery life.....	10
5.7 Instrument.....	10
5.8 About.....	10
6 Measurement modes.....	11
6.1 General synoptic.....	11
6.2 Determination of the daily noise exposure.....	12
7 Calibrate the instrument.....	13
7.1 Free field coefficient.....	13
7.2 Modification of the value of the reference source.....	13
7.3 Calibration.....	13
7.3.1 Calibration of V1 channel.....	14
7.3.2 Calibration of V2 channel.....	14
7.3.3 Calibration of D-MB microphone.....	14
8 Classical sound level meter.....	15
8.1 Settings before perform the measurement.....	15
8.2 Perform a measurement.....	15
9 Analyzer integrating-averaging sound level meter.....	16
9.1 Setting before performing the measurement.....	16
9.2 Perform a measurement.....	16
9.2.1 Explicative synoptic of the START/STOP mode.....	17
9.3 Consult values.....	18
10 Sonomètre intégrateur-moyenneur analyseur.....	18
10.1 Settings before perform the measurement : range selection.....	19
10.2 Measurement in progress : V1 channel.....	19
10.3 Measurement in progress : V1 + V2 channels.....	20
10.4 Measurement in progress : V1 channel and frequency analysis with filters by octave bands from 63 Hz to 8 kHz.....	21
10.5 Measurement in progress : V1+V2 channels and frequency analysis with filters by octave bands from 63 Hz to 8 kHz.....	22
10.6 Measurement in progress : audio recording on threshold.....	23
10.6.1 Temporal synoptic.....	24
10.6.2 Synoptic of the management of the recording dynamic.....	24
10.6.3 Use of audio recording.....	25
10.6.4 : Measurement in progress – Data reading.....	26
10.7 Measurement launching.....	27
10.7.1 Immediate mode.....	27
10.7.2 Delayed mode.....	27
10.7.3 Repetitive delayed mode.....	28
10.7.4 Free delayed mode.....	29
10.7.5 Delayed mode – measurement wait.....	29
10.7.6 Delayed mode – leave wait moment and stop the programming.....	29
10.8 Stop the measurement.....	30
10.9 Data processing.....	31

10.10 Data reading.....	31
10.11 Reading in V1 channel mode.....	32
10.12 Reading in V1+V2 channels mode.....	33
10.13 Reading : V1 channel mode and frequency analysis with filters by octave bands from 63 Hz to 8 kHz.....	34
10.14 Reading : V1+V2 channels mode and frequency analysis with filters by octave bands from 63 Hz to 8 kHz.....	35
10.15 Files transfer.....	36
10.16 Delete files.....	36
11 Running information.....	37
11.1 Instantaneous overload – percentage.....	37
11.2 Power supply.....	37
11.3 Over range measurement.....	37
11.4 Detection and counting of peak pressure levels 135-137-140 dB.....	37
11.5 Alarms.....	38
11.6 Auto Off.....	38
11.7 LCD locking.....	38
11.8 Stop locking – waiting mode.....	39
12 Maintenance.....	40
12.1 Care.....	40
12.2 Regular checking.....	40
12.3 Load the battery.....	40
13 Preparing for measurement.....	40
13.1 Preparing the instrument.....	40
13.1.1 Channel V1 measurement only.....	40
13.1.2 Measurement with V1 and V2 channels.....	41
13.1.3 Wearing the instrument.....	41
13.1.4 Fixing the microphone.....	41
13.1.5 Using the windscreen.....	42
14 Technical features.....	43
14.1 Standards.....	43
14.2 Metrology.....	43
14.3 Charger for battery.....	43
14.4 Dimensions – Weight.....	43
14.5 Audio recording capacity.....	44
14.6 Battery life.....	44
14.7 Delivery and packaging.....	44
14.8 Optional and accessories.....	44

The **DS300** noise dosimeter is a measuring instrument allowing measurement of noise exposure at workstation. Its advanced features make easier the investigation to determine and reduce noise pollution :

- frequency analysis by octave band for an optimal choice of protections
- two-channel dosimeter for simultaneous measurement of exposures suffered by the ears
- audio recording of noise sources on thresholds for a better identification

In accordance with international standards, **DS300** instrument calculates values usually used to compare with exposure regulatory values.

Thanks to its memory, **DS300** instrument stores measurement event timers which are then transferred to a computer and processed with **LDS23** software, supplied with the instrument.

LDS300 software supplied as option allows an analysis more detailed as per NF EN ISO9612 : 2009 standard.

In addition, this noise dosimeter has a classical sound level meter and analyzer integrating-averaging function for a 1st estimation of the noise environment of the workstation.

1.1 Presentation

DS 300 comes in the shape of a little case with ergonomics forms. It can be easily positioned on the belt or in a cloth pocket of people at their work station. the microphone at the end of extension is fixed thanks to a kit specially designed to minimize perturbations created by chocks or cloth frictions.

Measurements are stored in a microSD card memory of big capacity giving the whole an almost unlimited measurement capacity.

With its graphic backlighted LCD screen, **DS300** is also a a classical sound level meter and an integrating-averaging analyzer for a fast noise estimation at workstation.

During measurement, if necessary, it can advised people about levels through a two-coloured light.

1.2 Main features

Noise dosimeter and classical sound level meter and integrating-averaging analyzer with graphical backlighted LCD screen with :

- microphone with extension type electret of diameter 3/8" (9.52 mm) of little size allowing a reliable fixation
- 2 measurement channel : « **right ear** » side and « **left ear** » side (microphone and fixing kit for channel 2 as option)
- 3 dynamic ranges :
 - in running mode, one measurement channel : 40-140 dB range
 - in running mode, two measurement channels : 40-120 dB or 60-140 dB ranges
- Simultaneous measurement of Leq and LpK :
 - Leq : with A and C weightings and by octave band filters from 63 Hz to 8 kHz
 - LpK : with C or Z weightings
- Management of overrange of peak pressure levels 135-137-140 dB
- Audio recording on thresholds of noise sources (optional)
- Delayed and/or repetitive measurement start
- Keyboard protection during measurement and against unwanted stops
- Active or inactive LCD screen, visual alarms
- Calculation and results in accordance with NF EN ISO9612 : 2009 standard
- Storage capacity : 99 event timer of more 24h each
- Li-Ion battery for a battery-life better than 28 hours (according measurement programming)

All of the setting of **DS300** is directly performed with the keyboard or with the LDS300 software. **DS300** is supplied with the **LDS23** software which allows to transfer easily data to a computer to :

- visualize measurement data globally or more detailed
- process areas of non-measurement (break, beginning and end of measurement,...)
- customize report for saving and printing

2 General points

2.1 Regulatory

The 2003/10/CE European Guideline makes mention of instructions regarding the exposure of workers to risks. The regulatory requirements define a control context of noise pollution in work place. From these controls, the obtained results are compared with defined regulatory action thresholds.

These thresholds are based on two parameters :

- the daily noise exposure level $L_{ex,8}$ hours in dBA
- the LCpeak peak pressure level C-weighted

When thresholds are exceeded, actions have to be led.

The regulatory specifies two action thresholds causing preventive actions :

- the lower exposure value – **$L_{ex,8 h} > 80$ dBA and $LCpk > 135$ dB**
- the upper exposure value – **$L_{ex,8 h} > 85$ dBA and $LCpk > 137$ dB**

These two thresholds are completed by a third one called TLV, threshold limit value , which should not be exceeded in any case, with or without protection (PICB) : **$L_{ex,8 h} > 87$ dBA and $LCpk > 140$ dB.**

2.2 Labour law

It relies mainly on **R4433-1**, **R4433-2** and **R4433-7** articles and completed by the decree of the **19th July 2006**.

2.3 Measurement

It relies mainly on **R4433-1**, **R4433-2** and **R4433-7** articles and completed by the decree of the **19th July 2006**.

Measurement can be made according prescriptions of the NF EN ISO9612 : 2009 standard.

The standard recommends three measurements ways :

- by task
- by work or function
- by full day

This standard also specifies the measurement processing including the estimate of measurement uncertainty.

2.4 Noise exposure – Exposure points

This simplified way is especially adapted for workers whose position is constituted by several identifiable tasks. The difficulty to totalize levels dB does not allow a fast approach of the daily noise exposure, using this way brings a very significant operating flexibility.

It takes into account the noise exposure expressed in Pa^2h of the several tasks that can be then add to get a global noise exposure during the work day . From this, the determination $L_{ex,8h}$ daily exposure becomes easier by search in a dedicated corresponding table. This table is available in the ED6035 document edited by the INRS.

DS300 calculates the noise exposure and directly displays on its screen the number of exposure points regarding the task performed by the worker to his position.

LAF : A-weighted sound level pressure, fast time weighting (**F**ast) – range : 40-140
LAS : A-weighted sound level pressure, fast time weighting (**S**low) – range : 40-140
LCpK : peak pressure level in reference with 20µPa C-weighted
LZpK : peak pressure level in reference with 20µPa Z-weighted (Lin)

RST : reset of calculations of maximum or minimum values memorized – erasing of measurement session or of the whole memory.

Sto. : save and store data in the microSD card

DI : programmable duration of elementary integration from 1 s to 60 s for the calculation of the equivalent continuous level stored in the memory

LAeq,DI : A-weighted equivalent continuous level on DI duration

LCeq,DI : C-weighted equivalent continuous level on DI duration

LXeq,DI : A or C-weighted equivalent continuous level on DI duration or filtered by octave band from 63 Hz to 8 kHz DI duration.

LAeq,T : A-weighted equivalent continuous level on the total duration of measurement T

LCeq,T : T-weighted equivalent continuous level on the total duration of measurement T

LXeq,DT : or C-weighted equivalent continuous level on the total duration of measurement

Lex,d : A-weighted daily exposure level

EA,T : noise exposure on the measurement duration T in Pa²h

EA,d : noise exposure on the standardized duration of 8 hours in Pa²h

Dose : Noise dose in % - Reference : 85dBA during 8 hours

Lc : reference level for the calculation of the dose : 85dBA

Tc : duration reference for the calculation of Lex,d and dose : 8 hours

P.exp : exposure points - 1 exposure point = 0.01Pa²h

L135-L137-L140 : symbols for the detection of peak pressure levels of 135-137-140 dB

SXX : order number of event timers (or session). XX is limited 99.

EY : order number of the screens . Y goes from 1 to 6.

Dd : measurement start date. Format : 00/00/00

Hd : measurement beginning time. Format : 00:00

Df : measurement end date. Format : 00/00/00

Hf : measurement end time. Format : 00:00

V1- V2 : channel measurement

D-MB : microphone name

A/C : simultaneous measurement according A and C frequency weightings

A/C//63Hz-8kHz : simultaneous measurement according A and C frequency weightings and filters by octave band from 63 Hz to 8 kHz

00/00:00:00 : measurement duration format in days/hours:minutes:seconds

00:00 : current time format in hours:minutes

18/11/2010 : date format – JJ/MM/AAAA

00:00 : current time format in hours:minutes

Alarm : two-coloured visual alarm for detection

Audio : audio recording on exceeded thresholds

AutoOff : automatic stop of the instrument when it is stopped

Ver.Lcd / : LCD screen locking

Ver.Stop : locking of the Stop function during measurement

Ref : reference level for calibration

Cr.CI : free field correction term in calibration mode

Mem : number of possible session

4.1 Keyboard presentation

Turn on the instrument, three modes of operating are available. These modes are accessible with **1**, **2** and **3** keys. **5** key allows to go to reading settings or data transfer screens. **4** key is used to back to start screen from any mode. During measurement, **4** key also allows to leave the current screen.

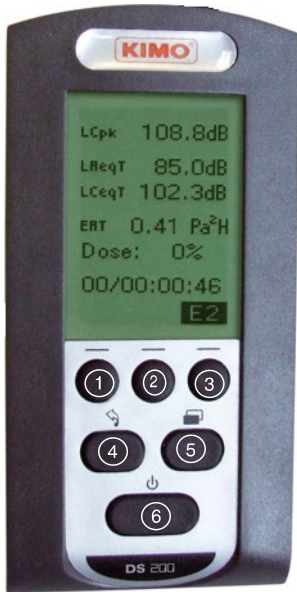

① ② ③ **Function keys** : they are directly linked to texts of the LCD screen situated at the top and allow to choose the measurement mode and setting.

④ **Exit key** : allows to leave current screen

⑤ **Screen key** : allows to go to others different screens from measurement screens

⑥ **Start/stop key**

Important note : **1 -2 -3** keys are representative of the text or logo situated on the top in the screen, which means :



: the measurement is in progress



: the measurement is finished or will be launched

4.2 Screen presentation

Three screens represent the different measurement and calibration modes et accessible with 1, 2 and 3 keys.

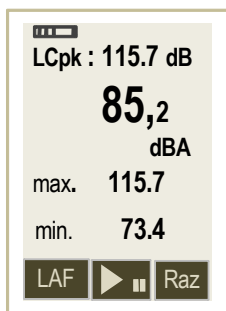

Classical sound level meter and frequency analyzer

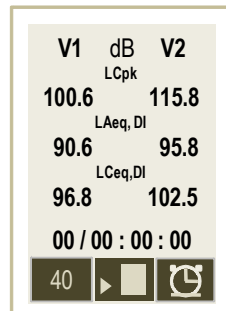
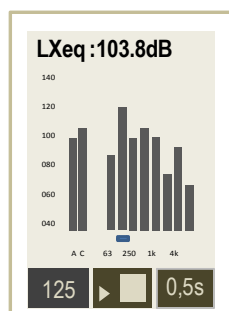

Analyser dosimeter-exposimeter with storage

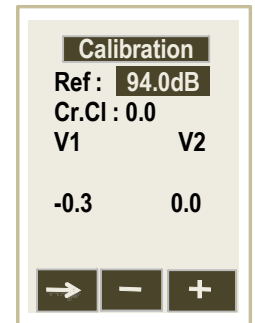

Calibration

Pressing **5** key shows the screen for the choice of the different available settings. Move the cursor with « **Arrows** » buttons then validate with the **3** key.

The setting of the instrument contains all the useful and necessary operations for a good processing of measurement, reading of results or data transfer. It also gives information about the correspondence with international standards, about the constitutive elements of the instrument and the date of the last check.

Measurement settings are automatically saved and reapointed in the next measurement.

5.1 Adjust the contrast / backlight

To optimize the reading of the display :

- Adjust the contrast pressing **1** and **2** function keys.
- Activate backlight of the LCD screen for an easy reading in a dark place.
No indicates without backlight and yes its activation. In this last case, battery life is reduced by about 5%.

Additional information :

- a brief press on Start/Stop key allows to activate backlight at any time. Same thing to deactivate it.
- in dosimeter integrator, backlight will deactivate automatically after a few moments to protect battery life .

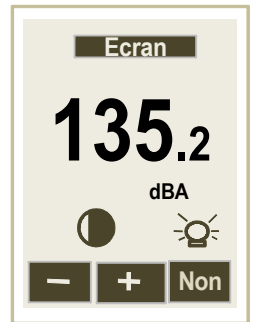
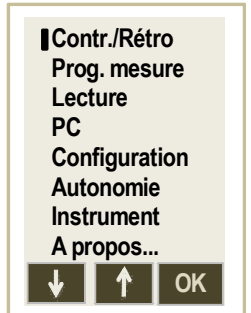

5.2 Measurement programming

Measurement programming has to be performed before launching measurement. Adjust settings according conditions and adopted measurement strategy.

- Press **1** key to move the cursor then modify the proposition in inverted video by pressing **2** or **3** keys.
- **V** : concerns the number of measurement channel : V1 or V1 and V2.
- **LpK** : choose C or Z for the weighting of the peak pressure level weighting. Usually, C weighting is preferred.
- **Di** : choose the duration of elementary integration of the equivalent continuous level for a good representation of the temporal evolution of the measurement. This duration goes from 1 s to 60 s by step of 1 s. Usually, a duration of 1 s is selected.
- **A/I/C** : Two possibilities are suggested :
 - the simultaneous measurement of Leq with A and C weightings : select **A/I/C** element.
 - the simultaneous measurement of Leq A and C weightings and filters by octave band from 63 Hz to 8 kHz : select **A/I/C/63-8 kHz** element.
- **Alarm** : it is about the illumination of the lights situated on the top of the housing visible by the holder of the dosimeter-noise dosimeter or the technician in charge of the measurement monitoring. Choose **yes** or **no** to make them visible or not.
- **Audio** : select **yes** to perform during the measurement a recording on threshold exceeded. In this case, press **1** key to select on the screen :
 - the reference used : **LAeq** or **Lpk**
 - threshold beyond which the recording begins. Set this threshold with **2** and **3** keys with a step of 1 dB.
 - the digital bonus of the recorder for optimization of the re-listening. Adjustable with **2** and **3** keys among values : **24-30-36-40-42-48 dB** (see page 24)

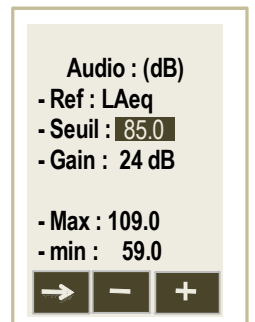

5.3 Reading

This screen allows to go to the main results of the different event timers stored in the memory of the instrument.

- Scroll with **2** or **3** keys the number of event timers to get the number of the required event timers.
The screen gives information about dates and times of beginning and ends of measurement and about measurement settings.
- Then press **1** key to read lire all of the other results.
- Scroll with **3** key the different screens in connection with event timers.
- Leave the event timers pressing **4** key.

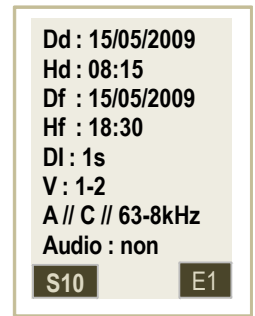
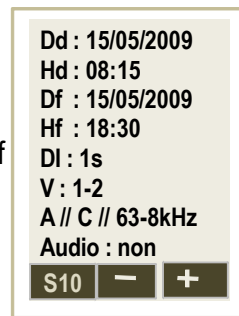

5.4 PC

From this screen, it is possible to clear the memory of the instrument pressing **1** key. A second press is necessary to validate this action.

In case of change of mind or error, press **4** key to stop this sequence.

Connect to the computer with USB cable.

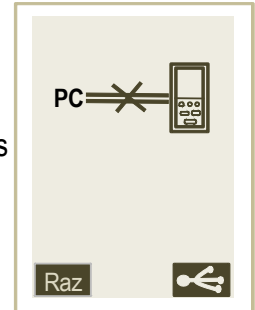

5.5 Configuration

From this screen, use the arrow **1** to move the cursor in the required area and modify with **2** and **3** keys the proposition. The different settings are :

- **Languages** : French or English
- **AutoOff** : yes or no. If yes is selected, the instrument will stop after 15 min of non-use. This allows to save battery life in case of omission to stop if no measurement is launched (see page 38).
- **V.Stop** : yes or no. If yes is selected, *unwanted stop of measurement* in storage is impossible.
- **V.Lcd** : yes or no. If yes is selected, LCD screen is off 60 seconds after the launching of measurement in storage mode.
To reactivate these two functions, enter a code with keypad (see pages 30 - 38). If no is selected, the two functions are functional.
- **Date** : update the date : day, month, year
- **Heure** : update the time : hours, minutes



5.6 Battery life

Autonomy gives information about the remaining memory capacity expressed in measurement period and the measurement duration according the remaining battery capacity (estimation linked to battery ageing et ambient conditions) :

Example : 96 means that the instrument can still perform 96 measurement event timers (1 measurement = 1 work station).

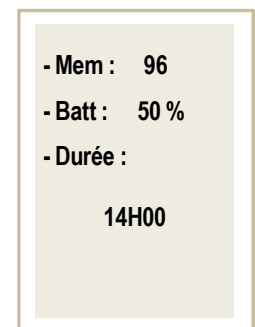

5.7 Instrument

This screen gives information about the main constitutive elements of the noise dosimeter :

- instrument and its serial number.
- microphones serial numbers (V1 or V1 and V2 and D-MB according to the case)
- the firmware version number

5.8 About

This screen gives information about the origin of manufacture, standards reference of the product and dates of last and next checks.

DS300 has two operating modes with calibration function in addition :

- Classical sound level meter mode and integrating-averaging analyzer **without storage** for a fast measurement.
- Integrating-averaging noise dosimeter, analyzer **with storage** for a study of daily exposure.

These functions are available from home screen : just press **1**, **2** or **3** keys associated with pictograms .

6.1 General synoptic

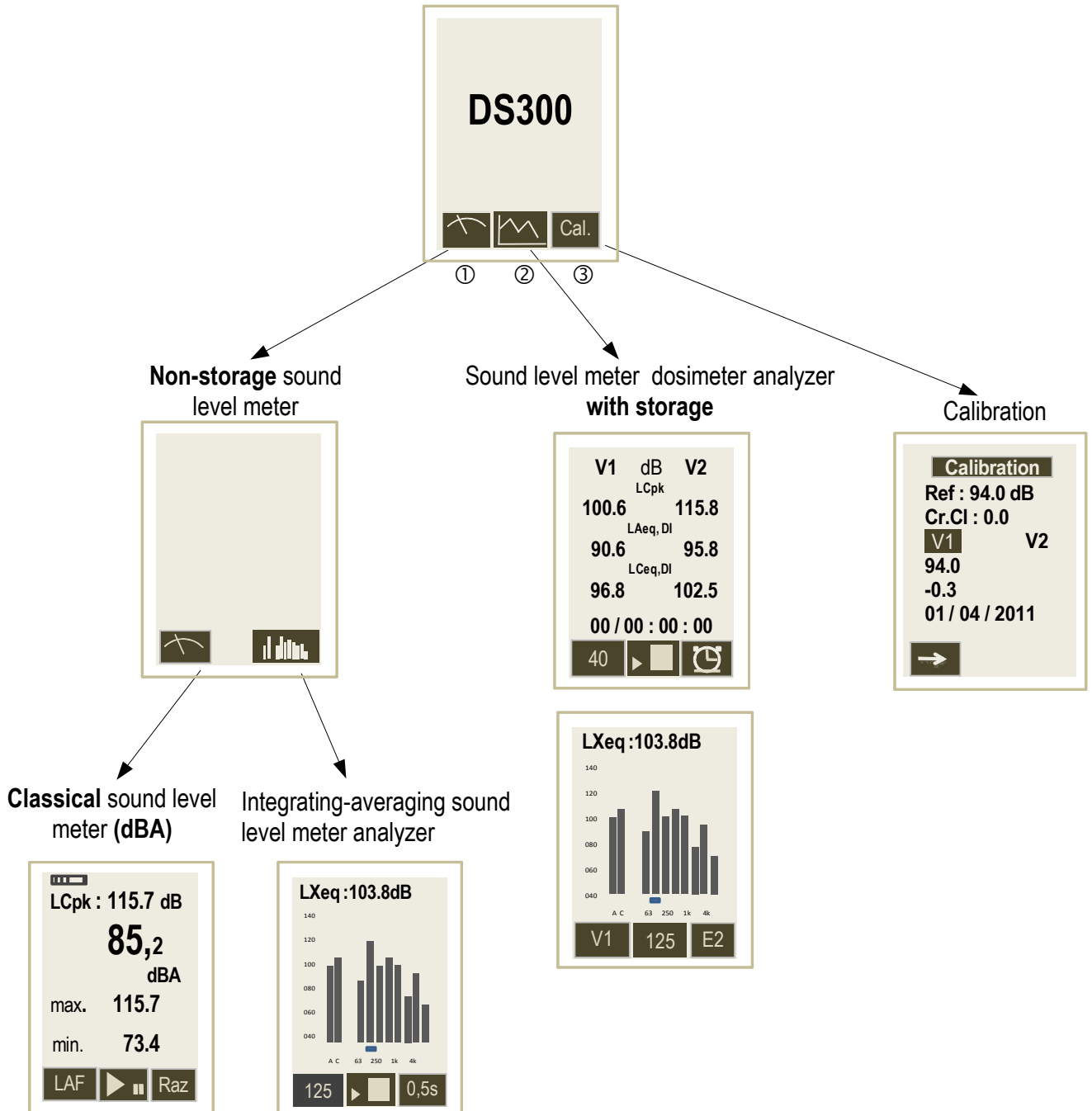

6.2 Determination of the daily noise exposure

Available possibilities (see options list page 44) of **DS300** are based on the level of required investigation and on the adopted measurement methodology.

So it is possible to :

- Measure on one or two channels simultaneously to determine the most exposed ear.
- Perform a frequency measurement with filters by octave bands from 63 Hz to 8 kHz on one or two channels. This analysis allows the optimum choice of personal protector against noise (PICB)
- Make from the channel 1 audio recorders on LAeq or LCpk levels exceeded for a better identification of noise sources.
- Perform temporal settings :
 - Multiple starts and stops on a work station in connection with identified tasks or samples linked to the employee function.
 - Multiple starts and stops on a weekly work station.

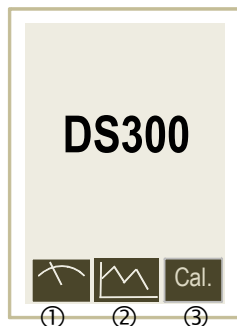

Note : according programmings, some metrological features of the noise dosimeter are adjusted.

From ② key :

One measurement channel : V1 with following features :

- **Channel** : exclusively V1
- **Microphone** : black sleeve or housing microphone D-MB
- **Dynamic range** : extended 40-140 dB
- **Weightings-filters** : A/C or A/C//63Hz-8kHz
- **Audio recording on threshold** : on V1 channel, yes or no – see table page 44
- **Alarm** : on V1 channel, yes or no
- **LCD screen** : off and locked, yes or no
- **Memory capacity** : 99 measurements of 24 hours minimum
- **Autonomy** : see table page 44
- **Measurement stop** : protected, yes or no

Or

Two measurement channels : V1 and V2 with following features :

- **V1 channel** : **black sleeve** microphone or housing microphone D-MB
- **V2 channel** : **blue sleeve** microphone
- **Dynamic range** : industrial 60-140 dB or service sector 40-120 dB
- **Weightings-filters** : A/C or A/C//63 Hz - 8 kHz
- **Audi recording on threshold** : on V1 channel, yes or no – see table page 44
- **Alarms** : on V1 and V2 channels, yes or no
- **LCD screen** : off and locked, yes or no
- **Memory capacity** : 99 measurements of 24 hours minimum
- **Autonomy** : see tableau page 44

- **Measurement stop** : protected, yes or no

And for both types of measurement (1 or 2 channels) :

Temporal setting for measurement launching :

- **immediate start** : manual
- **delayed starts and stops** : daily measurement
- **delayed repetitive starts and stops** : **weekly measurement** (repetitive daily time)
- **free starts and stops (with LDS300 software only)** : tasks or samples or weekly measurement (progressive daily time)

7 Calibrate the instrument

Before each measurement series, a calibration must be performed with an appropriate calibrator. A control will be also performed at the end of the measurement. The interval between both calibrations should not differ from more 0.5 dB. If not, performed measurements are questionable.

7.1 Free field coefficient

A sound reference source, calibrator or pistonphone, supplies a sound level pressure. During a measurement in free field, phenomena of diffraction due to microphone, housing and proximity of obstacles come to disrupt the measurement. This disruption is minimized if the microphone is away from the housing.

For **DS300**, correction in free field linked to microphone is insignificant and close to **0 dB**. This induces by the proximity of the microphone with the body of the person who wears the microphone is very complex and can not be expressed as free field correction but more reasonably as measurement uncertainty linked to microphone wearing.

So the **Cr.CI** free field correction reminded and unavailable on the screen is : **0.0 dB**.

7.2 Modification of the value of the reference source

- Select **Cal.** pressing **3** key from start screen.

The screen below appears.

The reference value pre-programmed during the manufacture of the instrument shows a priori that we are using a calibrator of nominal value of 94 dB (1000 Hz). Other values that can be met : 110 dB – 114 dB and 124 dB.

Note : the measuring is performed on the range 60-140 dB and in C-weighting, it is possible to use a calibrator or a pistonphone delivering a frequency of 250 Hz at a level of 124 dB without modification of free field correction.

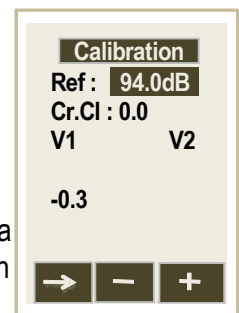

- The cursor is on « **Ref** ».
- Adjust the value dB by dB with « **+** » and « **-** » keys.
This value stays memorized until next change.

7.3 Calibration

- Insert into the calibrator the adapter ring **BC38** supplied with the **DS300** instrument.
It has to come to a stop down of the calibrator housing.
- Insert the microphone until the microphone comes to a stop down of the ring.
*This move has to be done slowly and smoothly so as not to damage the microphone.
Prefer to put vertically the sound level meter and the microphone.*
- Begin the procedure of calibration of the instrument as specified in the calibrator user manual.

Note : during calibration, avoid hard environmental conditions : ambient noise, shocks given involuntarily.

7.3.1 Calibration of V1 channel

- Select **Cal.** pressing **3** key from start screen.
- Check that the reference value corresponds to the one of the used calibrator.
- Turn on the calibrator and put it on the microphone of V1 channel.

Important : put the cursor on **V1** when using in mono channel.

The instrument automatically adjusts the gain of chain to get the coincidence of levels displayed in **Ref** and **V1**.

When the measurement is stabilized, a pictogram **OK** appears to validate. Press **3** key.

At this moment, the correction value of the gain and the calibration date are memorized and visible for the next calibration.

- Press **4** key to leave calibration function.

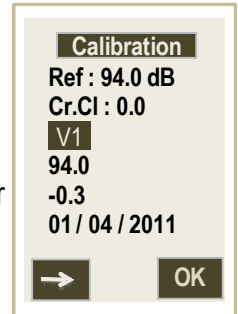

7.3.2 Calibration of V2 channel

V2 channel is accessible only if it is selected before in the « **Measurement programming** » menu.

- Turn on the calibrator and put it on the microphone of **V2** channel (blue sleeve).
- Put the cursor on **V2**.

The instrument automatically adjusts the gain of chain to get the coincidence of levels displayed in **Ref** and **V2**.

When the measurement is stabilized, a pictogram **OK** appears to validate. Press **3** key.

At this moment, the correction value of the gain and the calibration date are memorized and visible for the next calibration.

- Press **4** key to leave calibration function.

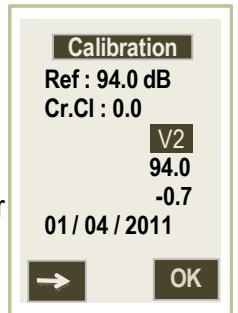

7.3.3 Calibration of D-MB microphone

D-MB housing microphone must be put on **V1** channel. It is automatically detected and **D-MB** inscription is displayed and information of previous calibration (correction and date).

- Turn on the calibrator and put it on the microphone.
- Put the cursor on **D-MB**.

The instrument automatically adjusts the gain of chain to get the coincidence of levels displayed in **Ref** and **D-MB**.

When the measurement is stabilized, a pictogram **OK** appears to validate. Press **3** key.

At this moment, the correction value of the gain and the calibration date are memorized and visible for the next calibration.

- Press **4** key to leave calibration function.

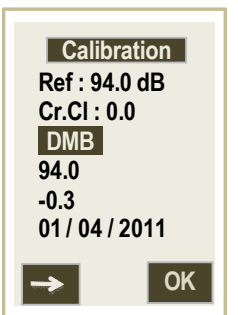

General note : the correction can not exceed **+/- 2 dB** for **DS300**. If the correction to be made exceeds **+/- 2 dB**, the coincidence of values in **1** and **2** is not obtained. **OK** pictogram is not displayed. You have to look for the reason of this difference : wrong calibrator positioning – defective battery – damaged microphone.

8 Classical sound level meter

Before each measurement, it is recommended to calibrate the instrument (see page 13).

- Press **1** key from start screen.
- Press another time **1** key to perform a fast measurement in classical sound level meter.



DS300 instrument processes the sound pressure signal and displays at the same time the following information :

- the temporally weighted sound pressure level
- maximum and minimum values of levels on the measurement duration
- the maximum peak level of sound pressure on the measurement duration

The used dynamic range allows a measurement from 40 to 140 dB without switching.

8.1 Settings before perform the measurement

- Choose the time constant pressing **1** key several times.

For A-weighting frequency, the instrument proposes the measurement according two time constants : fast (F) or slow (S). Possible choices are :

- **LAF** : dynamic range 40-140 dB – A-weighting frequency – F fast temporal weighting
- **LAS** : dynamic range 40-140 dB – A-weighting frequency – S slow temporal weighting

Note : C or Z frequency weightings of sound pressure peak level must be selected in « **Measurement programming** » menu.

8.2 Perform a measurement

Measurement is immediate.

During measurement, two actions are possible :

- reset memorized levels.
- hold measurement thanks to pause function.

To **reset** all the values :

- Press **3** key (**Raz** pictogram), resetting affects :
 - **LAF** or **LAS** maximum and minimum levels
 - **LCpk** maximum peak pressure value
 - information about overload

Pause function allows to stop the measurement in progress to avoid unwanted events or to perform a manual report of results.

- Press **2** key (hold pictogram)
- Press again **2** key to back to measurement.
- Leave classical sound level meter function and back to à home screen pressing **4** key.

9 Analyzer integrating-averaging sound level meter

Before each measurement, it is recommended to calibrate the instrument (see page 13).

- Press **1** key from start screen.
- Press **3** key to perform a fast measurement in analyzer integrating-averaging sound level meter.



DS300 processes sound pressure signal and displays simultaneously the following results :

- A and C weighted LXeq equivalent continuous levels and filtered by octave bands from 63 Hz to 8 kHz on an elementary duration of 0.5 s.
- A and C weighted LXeq equivalent continuous levels and filtered by octave bands from 63 Hz to 8 kHz on a T elementary duration.
- Maximum and minimum values of equivalent continuous levels of duration of 0.5 since the beginning of measurement.
- Maximum peak level of LCpK sound pressure on T measurement duration.

9.1 Setting before performing the measurement

The used dynamic range allows a measurement from 40 to 140 dB without switching.





C or Z frequency weighting of sound pressure peak level must be selected in « **Measurement programming** » menu.

9.2 Perform a measurement

The screen displays continuously, as spectral representation :

- **LXeq** : the equivalent continuous levels 0,5 s. A and C weighted and filtered by octave bands from 63 Hz to 8 kHz

Launch measurement on a **T** free duration according to the **Start/Stop** principle :

- Press **2** key ( pictogram) to start the measurement on a T duration.
- Press again **2** key ( pictogram) to stop measurement.
- Measurement values are reset with a new press on **2** key ( pictogram).
- Press **2** key to launch a new measurement ( pictogram).

During or at the end of the measurement :

- Consult the different screens and LXeq,0.5 s, LXeq,T values and minimum and maximum values (maximum and minimum spectrum) pressing **3** key.
- Leave the analyzer integrating-averaging sound level meter function and back to home screen pressing **4** key.

9.2.1 Explicative synoptic of the START/STOP mode



9.3 Consult values

Screens of T, Max or min. values are available only if a measurement is launched (press **2** key). Values reading is performed during measurement or at the end of the measurement. Press **3** key to go to successively :

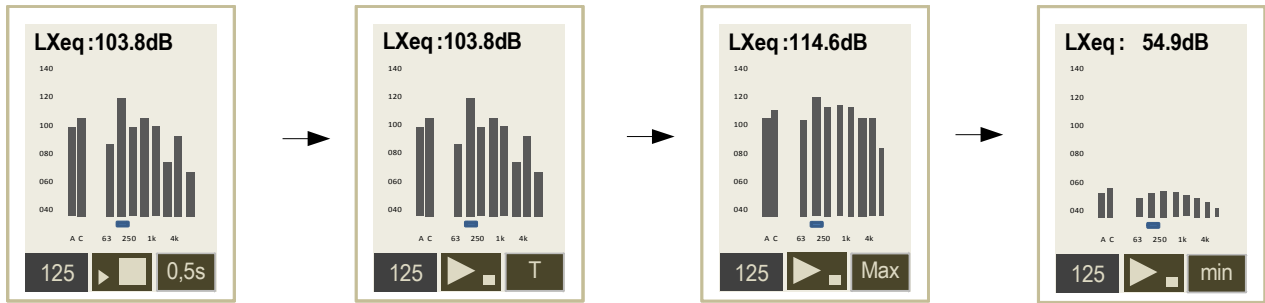

In each screen, press **1** key to scroll successively all LXeq,0.5s or LXeq,T or LXeqMax or LXeqMin values.

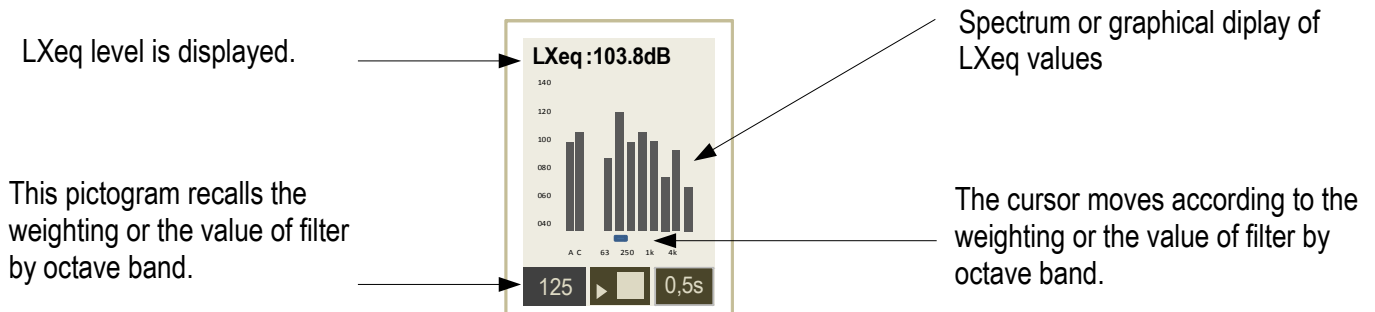

All the values are reset when a new measurement is launched (**2** key: Start/Stop).

- Press **2** key. Resetting concerns :
 - LXeq,T global levels, LXeqMax, LXeqMin memorized values .
 - Overload information (if present).
- Press **4** key to leave analyzer integrating-averaging sound level meter function and back to home screen.

10 Sonomètre intégrateur-moyenneur analyseur

Before each measurement, it is recommended to calibrate the instrument (see page 13).

Measurement settings will have been previously defined in the « **Measurement programming** » menu. This is about :

- use of 1 or 2 measurement channels : V1 or V1 and V2.
 - selection of C or Z weightings of sound pressure peak level : usually C.
 - setting of duration of elementary integration of the equivalent continuous level : usually 1 s.
 - measurement of equivalent continuous level simultaneously with both frequency weightings A and C and with or without frequency analysis from 63 Hz to 8 kHz.
 - activation or not of visual alarms.
 - activation or not of audio recording on threshold.
- From start screen, press **2** key.

In order to check the proper operating of the measurement chain before launching a measurement, **DS300** instrument processes the sound pressure signal and displays according to the initial programming (V1 only or V1 and V2) :

- the equivalent continuous levels of A and C weighted sound pressure for each duration of each elementary integration*- LAeq,DI / LCeq,DI
- the peak level of maximum sound pressure of each elementary integration : LCpk
- measurement duration format given in DD/HH:MM:SS

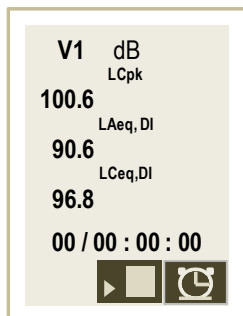

V1 : single range of 40-140 dB

Remind of the used dynamic range
40 for 40-120 dB
60 for 60-140 dB

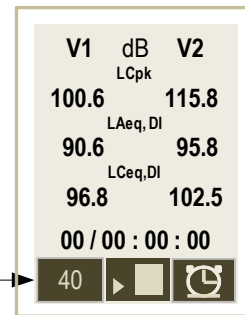

V2 : possible ranges :
 40-120 dB
 60-140 dB

*results are displayed on this screen each second. After the launching, results will be displayed at the rate of the duration of elementary integration (from 1 s to 60 s).

10.1 Settings before perform the measurement : range selection

The used dynamic range is according to measurement mode :

- **V1 channel mode** : single dynamic range 40-140 dB (peak 143 dB)
- **V1+V2 channels mode** : possible selection between 2 dynamic ranges pressing **1** key

40 40-120 dB : service sector or light industry

60 60-140 dB (peak 143 dB) : industry

The individual dosimeter is a specific instrument wear by a person exposed to sound pollution. Usually, the reading of results is made at the end of measurement.

DS300 instrument has a special feature : it can be used just as a hand sound level meter de, so partial results during measurement can be accessible as described below.

10.2 Measurement in progress : V1 channel

- From start screen, press **3** key to scroll screens from **E1** to **E4** .
- Press **4** key to back to general screen of measurement.

E2 : results screen :

- maximum LCpk on T measurement duration
- LAeq,T, LCeq on T measurement duration
- EA,T sound exposure on measurement duration
- Sound dose given in % referenced at 85 dB during 8H00
- Duration of the measurement in progress

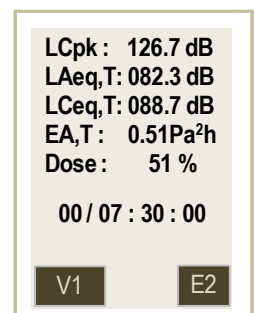
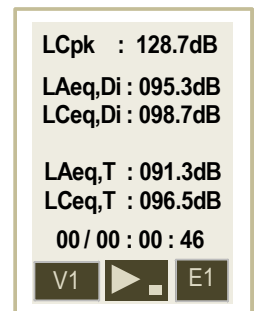

E3 : detection screen of overloads and values of peak level 135-137-140 dB (see page 37)

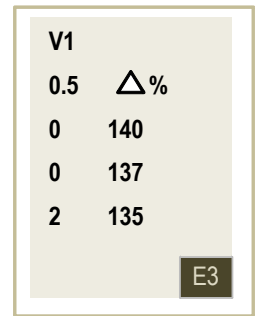

E4 : remind screen of measurement settings for V1 channel.

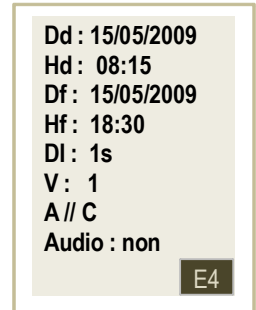

10.3 Measurement in progress : V1 + V2 channels

- From start screen, press 3 key to scroll screens from E1 to E4
- Press 1 key to go from V1 screen to V2 screen.
- Press 4 key to back to general screen of measurement.

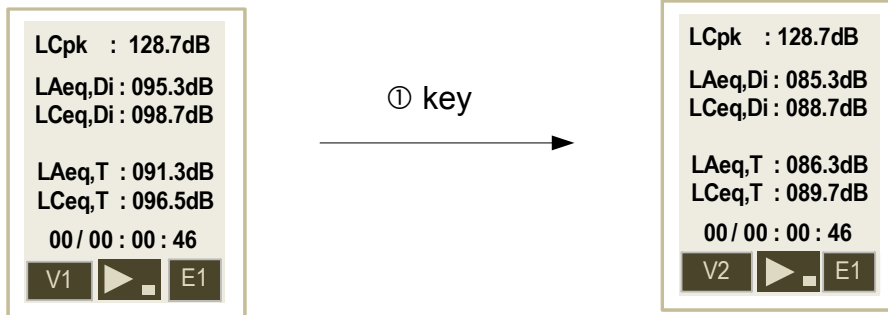

E2 : Results screen :

- maximum LCpk on T measurement duration
- LAeq,T, LCeq on T measurement duration
- EA,T sound exposure on measurement duration
- Sound dose given in % referenced at 85 dB during 8H00
- Duration of the measurement in progress

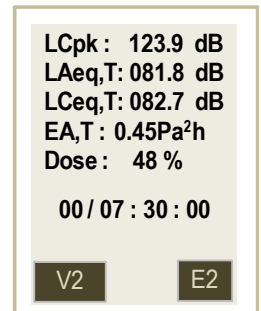
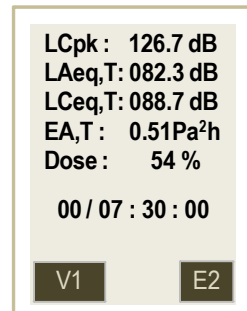

E3 : detection screen of both V1 and V2 channels, overloads and values of peak level 135-137-140 dB (see page 37).

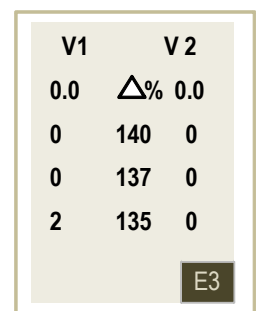

E4: remind screen of measurement settings for V1 and V2 channels.

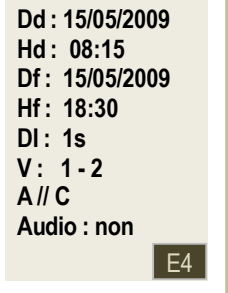

10.4 Measurement in progress : V1 channel and frequency analysis with filters by octave bands from 63 Hz to 8 kHz

- From general screen of measurement, press **3** key to scroll screens from **E1** to **E5**.
- Press **4** key to back to general screen of measurement.

E2 : Screen of frequency analysis from 63 Hz to 8 kHz with graphical representation of LXeq,DI
 To read values :

- Press **2** key.
*The cursor moves in relation with weighting or value of the filter by octave band and letter X of LXeq,DI indicated inside the pictogram.
 LXeq,DI level is displayed on the top.*

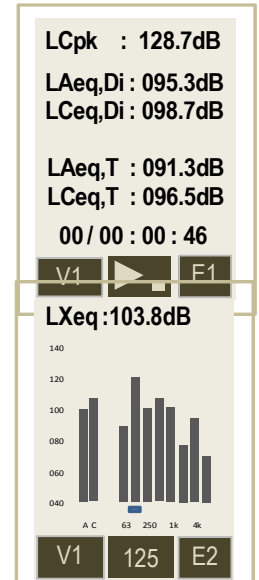

E3 : results screen :

- maximum LCpk on T measurement duration
- LAeq,T, LCeq on T measurement duration
- EA,T sound exposure on measurement duration
- Sound dose given in % referenced at 85 dB during 8H00
- Measurement duration

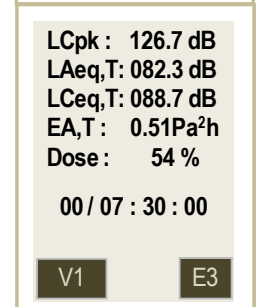

E4 : detection screen of overloads and values of peak level 135-137-140 dB (see page 37).

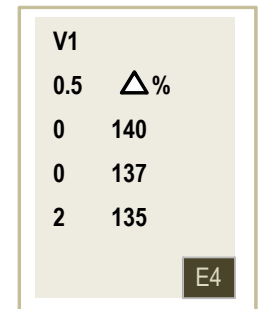

E5 : remind screen of measurement settings for V1 channel.



10.5 Measurement in progress : V1+V2 channels and frequency analysis with filters by octave bands from 63 Hz to 8 kHz

- From general screen of measurement, press 3 key to scroll screens from E1 to E5.
- Press 1 key to go from V1 screen to V2 screen.
- Press 4 key to back to general screen of measurement.

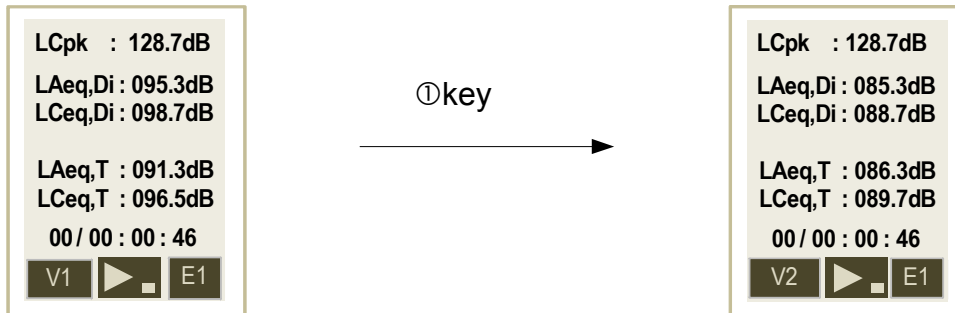

E2 : Screen of frequency analysis from 63 Hz to 8 kHz with graphical representation of LXeq,DI

To read values :

- Press 2 key.
The cursor moves in relation with weighting or value of the filter by octave band and letter X of LXeq,DI indicated inside the pictogram. LXeq,DI level is displayed on the top.

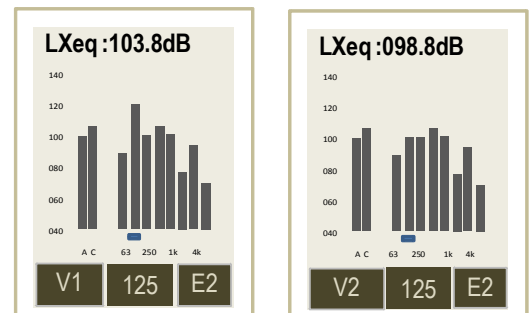

E3 : results screen :

- maximum LCpk on T measurement duration
- LAeq,T, LCeq on T measurement duration
- EA,T sound exposure on measurement duration
- Sound dose given in % referenced at 85 dB during 8H00.
- Measurement duration

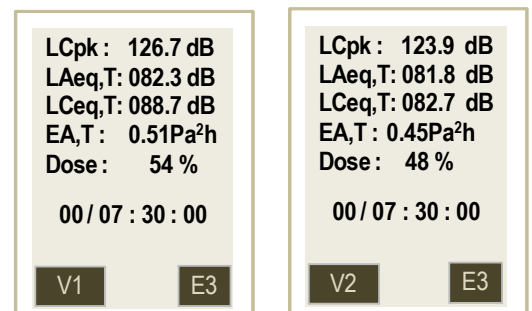

E4 : detection screen of both V1 and V2 channels, overloads and values of peak level 135-137-140 dB (see page 37).

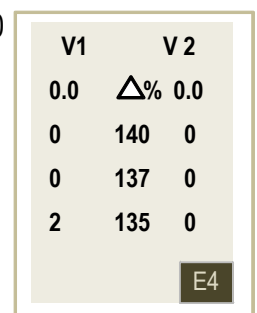

E5 : remind screen of measurement settings for V1 and V2 channels.

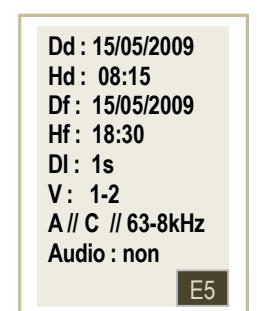

10.6 Measurement in progress : audio recording on threshold

During data processing of a measurement and after visualization of temporal evolution with **LDS23** or **LDS300** software, some results can be surprising and stir up questions :

- Is the obtained value come from a measurement artefact ?
- What is the sound source at the origin of this level ?

To help you, **DS300** instrument is equipped with an « **audio recording** » function that is automatically activated for a threshold exceeding previously set.

This detection threshold concerns :

- the A-weighted equivalent continuous level on a duration of elementary integration of 1 second : **LAeq,1s**
OR
- the C or Z weighted maximum peak pressure level (according to the set weighting : usually C) : **LCpk**
- the recording principle after detection threshold suggests that sound source at the origin of this threshold exceeding can not be active anymore after the detection. As a consequence, **DS300** performs systematically a rolling recording of duration **Tgl** (4 s) preserved after threshold detection.
- the recording continues on the total duration of threshold and after threshold underflow, it goes on the same **Tgl** duration previously used.
- this method allows an « **audio recording** » of the sound source at the origin of the threshold and makes easier its identification.

As it is an help for recognition of sound sources at to optimize hardware resources, the audio recording format on the SD card is defined as follows :

- accuracy : 16 bits
- sampling : 12 kHz

DS300 instrument having a wide measurement dynamic, 100dB, it is likely that the re-listening with a computer do not allows an easy identification according to selected detection threshold.

To optimize the listening, the audio recorder incorporates an adjustable digital gain from **24 to 48dB** with a step of **6dB**. This adjustment has no incidence on the measurement and interferes on audio files only.

So, according to measurement conditions selection criteria, this adjustment allows to adjust the reduced dynamic of audio listening (computer + ear + environment = about 50 dB) to this more extensive of **DS300** instrument (100dB).

Important : To make more comfortable the re-listening on PC, we advise the use of an external amplified speaker system to the PC.

10.6.1 Temporal synoptic

 Exceeding area of sound level on threshold : ex : 87 dB

 Tgl : pre and post recording fixed at 4 seconds for supervision of audio exceeding on threshold

 Final recording : pre and post exceeding + exceeding

VERY IMPORTANT : when audio function is activated, the DI duration of elementary integration for calculation of the LAeq et LCEq equivalent continuous level is automatically set at 1 second.

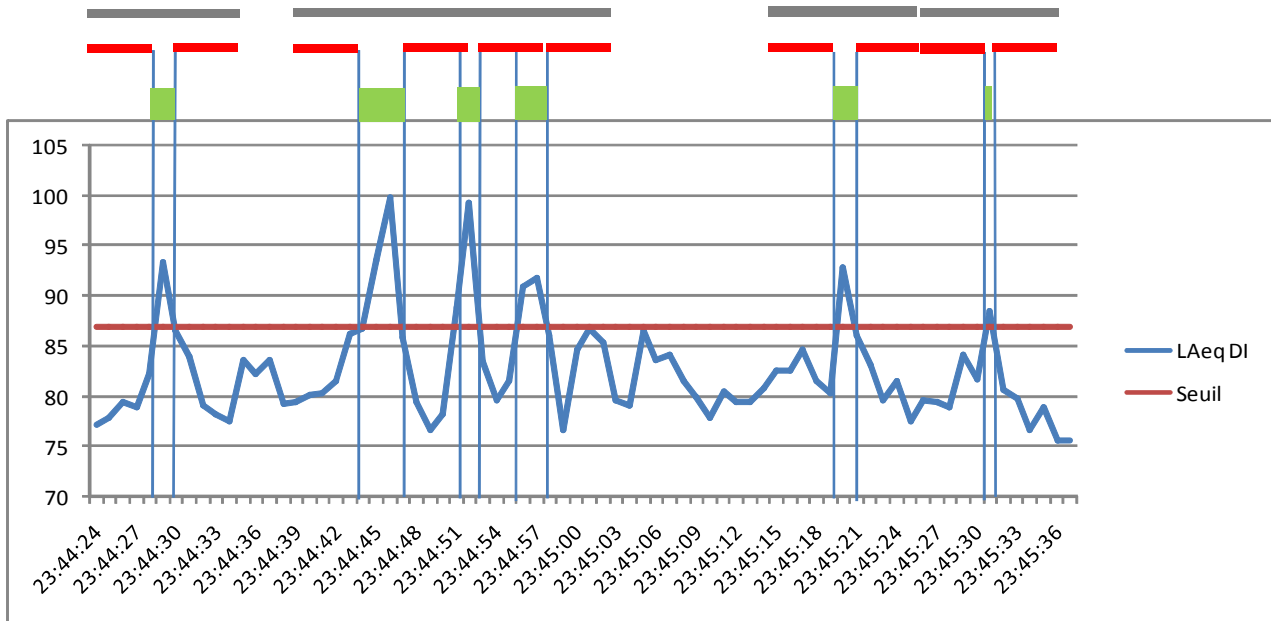

10.6.2 Synoptic of the management of the recording dynamic



Selection of a detection level for audio recording : it must be on the planned measuring range : 40-120 or 60-140 in two-channel operating V1 and V2 or 40-140 in one-channel operating V1.

Example : do not choose a 125 dB threshold on the 40-120 range !!!

Setting of the digital gain for audio recording : recorder dynamic is set in factory at **30dB**.

This means that the recorder has 30dB in storage in peak pressure value beyond the selected detection threshold in LAeq or LCpk.

Example : detection level = LAeq 1s : 105 dBA

Sound sources higher to this threshold are recorded without distortion if and only if the maximum peak level does not exceed : $105+30 = 135\text{dB}$ peak.

In general, sound sources have some high peak factors, pretty much from **20 to 30 dB**. That's why it is not possible to set the gain at a value lower than **24 dB**. However, in situations where sound sources are elaborated with peak factors very high, it is possible to choose the digital gain beyond 30 db between **36, 42 and 48 dB**.

During programming, **DS300** instrument displays, according to selected criterion (reference threshold and digital gain), the minimum and maximum peak pressure levels recordable properly.

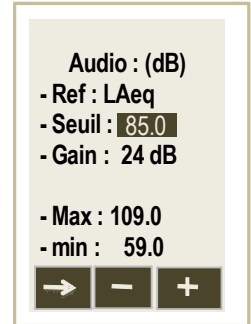

Listening comfort :

It is recommended to keep the factory setting which is 30 dB. Eventually, after experiences on site, it is possible to bring to 24dB.

In this case, the re-listening allows a correct identification for the 4 seconds before and after scheduled threshold exceeding.

10.6.3 Use of audio recording

- From **MENU** screen, select « **Progr.mesure** » with **1** and **2** keys.
- Validate with **3 key**.
- Press **1** key to move the cursor until **Audio** element.
- Select **YES** in reverse video pressing **2** or **3** key.
DI item will show automatically : DI : 1 s.
- Press **1** key to select :
 - Reference used for detection : **LAeq** or **Lpk**.
 - Threshold beyond from which recording starts. This threshold is adjustable with **2** and **3** keys by 1 dB step. It concerns either **LAeq** or **Lpk** according to previous choice.
 - Gain of chain of recording adjustable from **24dB** to **48dB** by **6dB** step. According to these choices, calculated minimum and maximum values of peak pressure levels recordable properly are displayed.

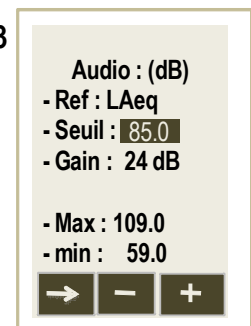
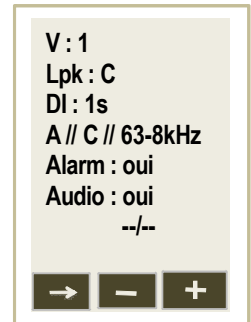
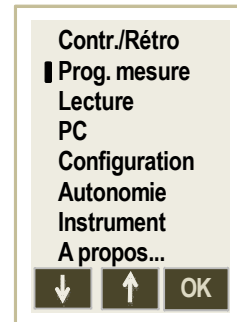

Please note : **Durations** of pre and post recordings supervising the exceeding are not adjustable and fixed at 4 seconds.

Measurement in progress :

Different recordings are performed automatically without intervention and without affect metrological calculations. Total recording time available being limited (see page 44), be selective to select the detection threshold value in order to not use too quickly memory space and get repetitive and insignificant recordings.

Audio files :

All recordings are linked to the corresponding metrological file and saved as *.wav audio format on the micro SD card. During data transfer on a PC, LDS300 software processes all the files and the re-listening of files to help about sound sources recognition.

Memory space :

Available memory on micro SD card is divided into 2 areas : 1st one contains the metrological files and the 2nd one contains audio files for re-listening.

Before starting a new measurement, it is advisable to check the remaining measurement capacity expressed in number of event timers and battery capacity.

For that, from MENU screen :

- Select with 1 or 2 key **Autonomy** item.
- Validate with 3 key .
- Check number of event timers and battery capacity.
Ex : 96 event timers and 14H00

In case of insufficiency, all data in the micro SD card must be deleted :

- with keypad (see page 36)
- with LDS23 or LDS300 software.

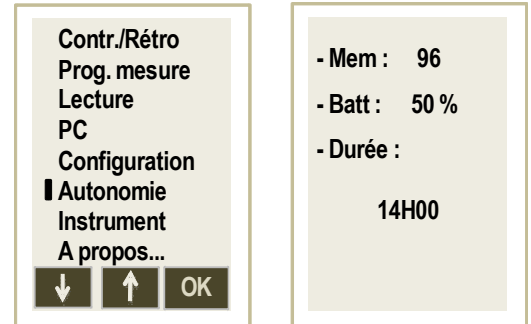

WARNING :

Tell the person wearing the instrument that “**Audio recording**” function is activated.

Only the person in charge of the measurement has the responsibility to process recordings.

10.6.4 : Measurement in progress – Data reading

Audio function generates an additional screen control which completes the screen chain during measurement or at the end for reading of results.

E5 (during measurement), E6 (in reading mode after measurement) : counting screens audio recordings with remind of start parameters (see page 25).

Please not : audio recording is performed on the reference channel V1 only.

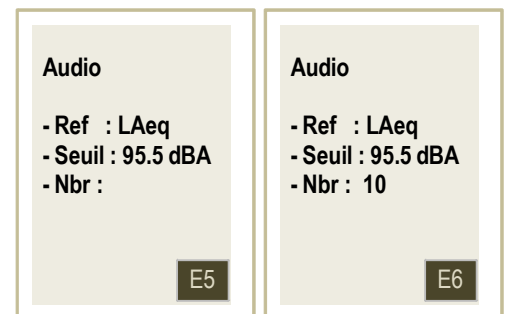

Ex 1: Screens chain during measurement : V1 channel / frequency analysis / Audio :

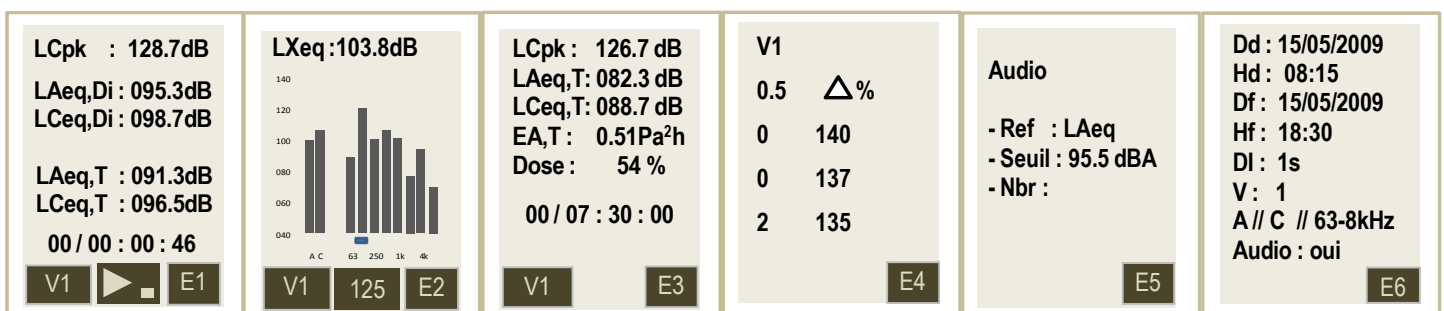

Ex 2: Screens chain during data reading : V1-V2 channels / frequency analysis / Audio

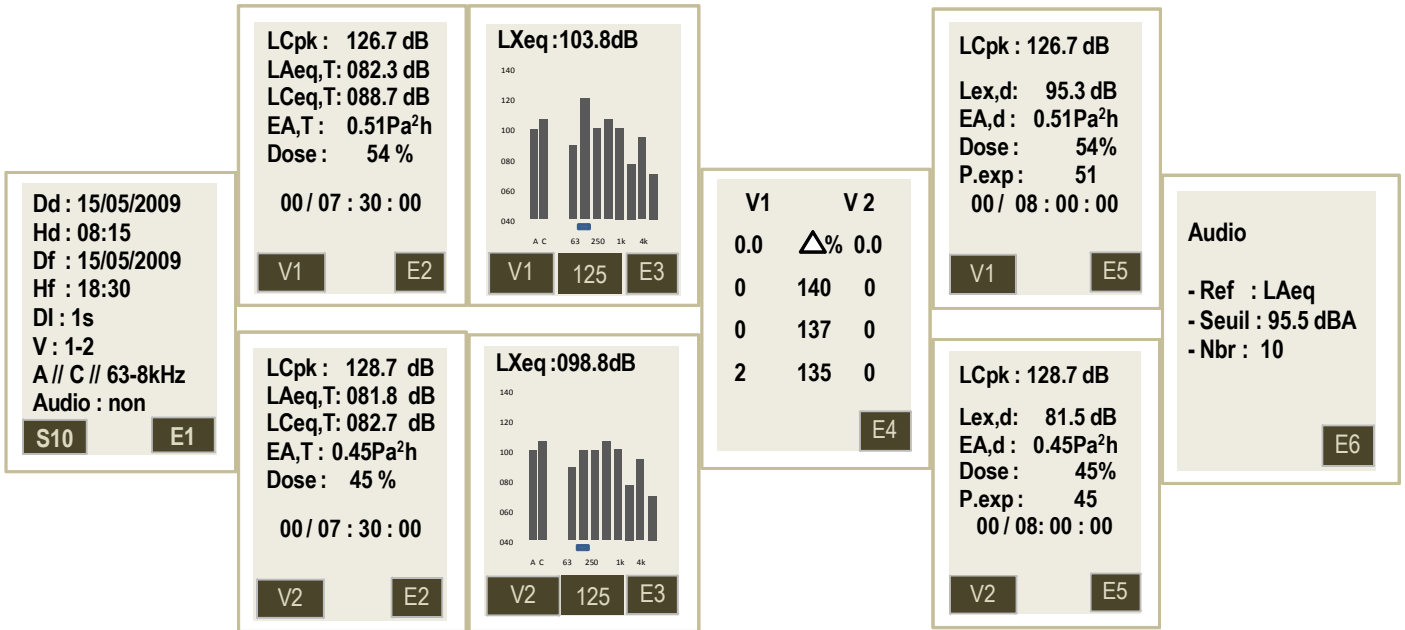

Please not : audio recording is performed on the reference channel V1 only.

10.7 Measurement launching

DS300 instrument proposes four modes to launch the measurement :

- **Immediate mode** : manual launching with keypad
- **Delayed mode** : programmable launching and stop
- **Repetitive delayed mode** : from 2 to 10 times maximum the programming realized in delayed mode.
- **Free mode** : programming from 1 to 10 free periods, start and end dates and hours, requires imperatively **LDS300** software.

10.7.1 Immediate mode

- Press **2** key. Measurement starts immediately, *results are displayed at the rate of integration duration.*

10.7.2 Delayed mode

It is possible to set start and end of measurement (date-time) in case of absence. For example : preparation of the instrument the day before the study of night-work.

- Press **3** key . Programming screen is displayed.
- Move the cursor with **1** key (arrow).
- Change the different items with **2** and **3** keys :
 - **Db** : date of measurement beginning
 - **Hb** : time of measurement beginning
 - **De** : date of measurement end
 - **He** : time of measurement end
- Keep the element **Repet** at **01**.
- Move the cursor imperatively until **OK** is displayed at the bottom right of the screen.
- Press **3** key linked to this pictogram.

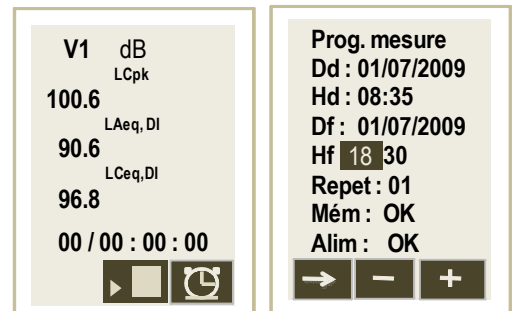

Programming of measurement launching is performed.

The last two lines specifies :

- that memory capacity is sufficient : **OK**
- that battery capacity allows the measurement : **OK**.

In case of incompatibility, **KO** is displayed for **OK**. In this case :

- Erase memory of the instrument.
- Load the battery.

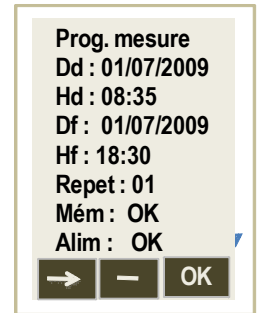

Important note : by using the delayed mode without programming beginning date and time (current date and time always present) but by programming end date and time, measurement launches immediately when it is validated and will stop at the programmed time. This programming allows a measurement and instrument stop without being present.

10.7.3 Repetitive delayed mode

As previously, it is possible to set measurement end and beginning at moments (date-time) in case of absence and according to an established period.

For example : following of a weekly noise exposure in case of night-work

- Set date and time of **first measurement** beginning and end
- Indicate the number of measurements to perform the following days at the same times
- Move the cursor with **1 key** (arrow).

- Change the different items with **2** and **3** keys :

- **Db** : date of measurement beginning
- **Hb** : time of measurement beginning
- **De** : date of measurement end
- **He** : time of measurement end

- Change **Repet** : **01** element indicating the number of required repetitive measurement from **02** to **10**.

- Move the cursor imperatively until **OK** is displayed at the bottom right of the screen.

- Press **3** key linked to this pictogram.

Programming of measurement launching is performed.

The last two lines specifies :

- that memory capacity is sufficient : **OK**
- that battery capacity allows the measurement : **OK**.

In case of incompatibility, **KO** is displayed for **OK**. In this case :

- Erase memory of the instrument (see page 36).
- Load the battery.

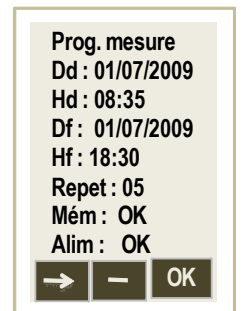
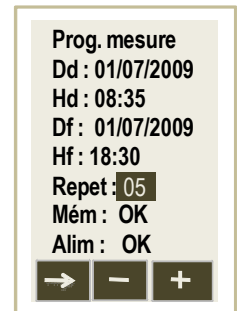

Note : about battery loading, **KO** will be displayed if and only if the residual capacity does not allow to perform the first measurement. You must load the battery before any launching of measurements.

10.7.4 Free delayed mode

As previously, it is possible to set measurement end and beginning at moments (date-time) in case of absence and according to a non-periodic free distribution. The programming is only accessible through the **LDS300** software and is restricted to **10 periods**. It is possible to use this mode if the « **measurement by function** » meeting NF EN ISO 9612 : 2009 standard has been selected as measurement strategy. These periods appear as **exploitable samples** in an analysis of HEG (homogeneous exposure group) (see LDS300 user manual).

10.7.5 Delayed mode – measurement wait

The principle of a delayed or free repetitive delayed measurement imposes a temporal management of the instrument which is as follows :

- programming is made validate.
- waiting mode is displayed. This screen is displayed a few moment then turns off.
- the instrument moves to sleep mode to keep battery capacity. It reactivates itself a few moment before the measurement.
- measurement is performed, data are recorded, The instrument moves to sleep mode until next measurement and so on.

Screen details :

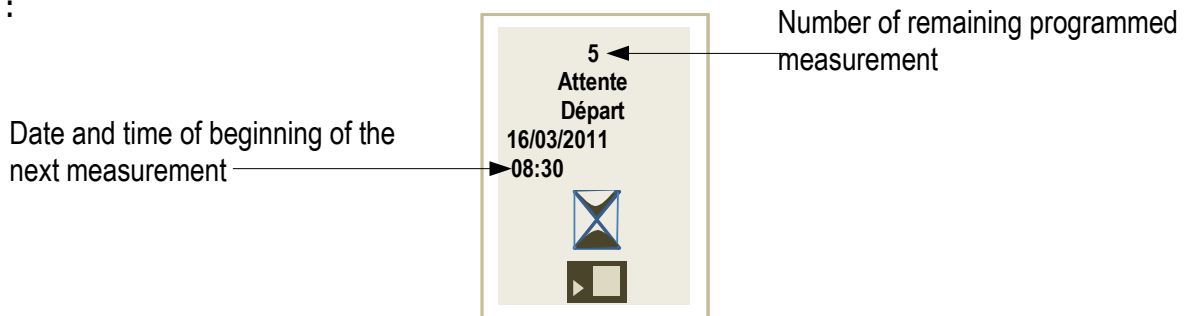

Important : it is possible at any time to stop sleep or waiting mode or and launch the measurement. In waiting mode, just press **2** key. Measurement starts immediately.
In sleep mode between two measurements :

- Press **On/Off** key (6 key).
Waiting screen is displayed.
- Press **2** key to start measurement.

In all cases, only measurement launching is modified, end programming and daily repetitive programming are the same as the ones initially programmed.

10.7.6 Delayed mode – leave wait moment and stop the programming

It is possible at any time to stop the sleep or waiting mode and stop the measurement in progress.

In sleep mode before measurement :

- Press **On/Off** key (6 key).
Waiting screen is displayed.
- Press **4** key (escape) .

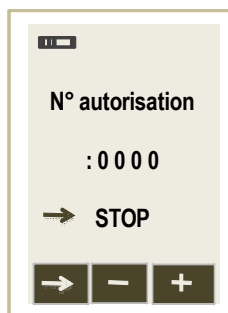

Mode Lock. Stop activated

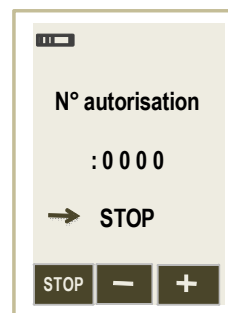

Mode Lock. Stop non activated

To confirm the exit of « **Waiting** » mode, the **authorization number** must be filled in (if **Ver.Stop** has been activated).

- Move the cursor in video-inverted to **0000** number present in middle of the screen.
- Choose successively numbers with **2** and **3** keys.
- Move the cursor to **STOP** arrow after the least number.
- Press **1** key to validate **STOP** (directly if **Ver.Stop** function is inactivated).

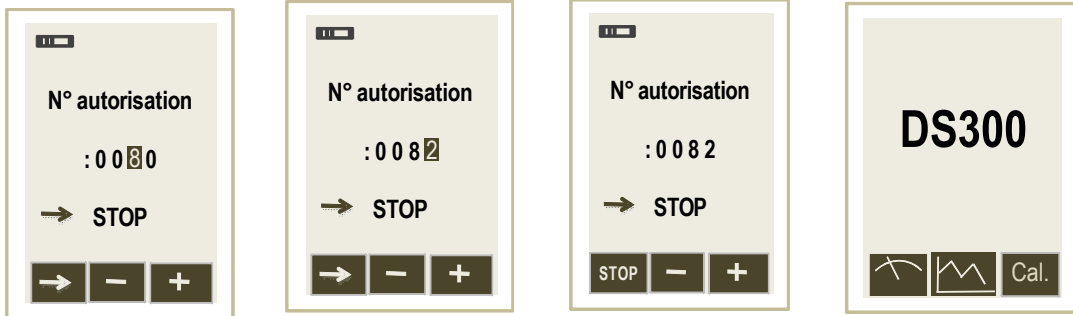

*Waiting mode is stopped, « **Delayed mode** » programming is completely cancelled – Back to start screen.*

- **IMPORTANT** : authorization number is **0082**.

***Note** : it is possible to change and custom the protection code. For that, please see LDS300 software user manual.*

10.8 Stop the measurement

In case of manual launching of the measurement, usually a manual stop must be realized from general measurement screen.

- Press **2** key.



To confirm the stop or to avoid an unwanted stop, the **authorization number** must be filled in :

- Move the cursor in video-inverted to **0000** number present in middle of the screen.
- Choose successively numbers with **2** and **3** keys.
- Move the cursor to **STOP** arrow after the least number.
- Press **1** key to validate **STOP**.



Measurement stops, a screen to save or erase the dataset appears.

IMPORTANT : authorization number is **0082**.

To stop the instrument : press a few seconds **6** key until the screen turns off.

Note : a fast press on this same key turns on or off the backlight.

Note : it is possible to custom the protection code. For that, please see the **LDS300** software user manual.

10.9 Data processing

At the end of measurement, it is possible to store data and create a dataset or reject the measurement and erase data.

Accepter measurements and store them :

- Press **once 3** key (« **Sto.** »).
A banner visualizes the storage phase.

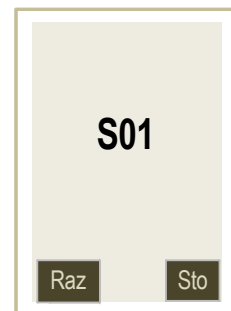

Reject measurements and do not store them :

- Press **twice 1** key (« **Raz** »).
A banner visualizes the data deletion phase.



10.10 Data reading

All the measurements are stored in a micro SD card in the form of files called datasets. Ex : S01-S02-S03....

In order to take notice of measurement results before transfer to a computer, proceed as follow :

- Press **5** key from start screen.
- Move the cursor **Read** item with **1** or **2** keys.

- Validate with **3** key (**OK**).

Configuration screen of the last dataset is displayed.

To consult the other datasets, scroll with **2** or **3** key until get the required number.

Configuration screen of each dataset makes easier its search.

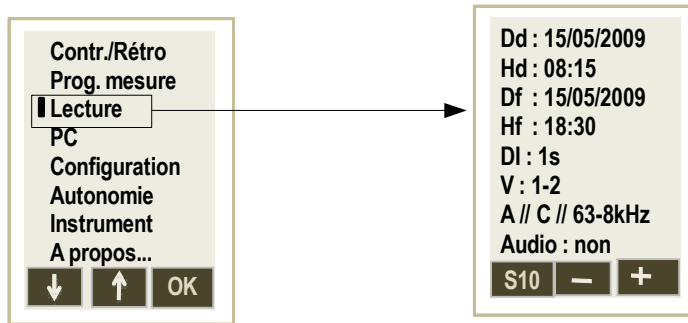

- When required dataset number appears, press **1** key.
Several screens characterized the dataset.
- Press successively on **3** key to scroll the different screens.
These screens are sometimes different and linked to programming mode :
 - V1 channel without frequency analysis
 - V1 + V2 channels without frequency analysis
 - V1 channel with frequency analysis
 - V1 + V2 channels with frequency analysis
- From main screen, press successively on **3** key to scroll **E1** to **E5** screens.

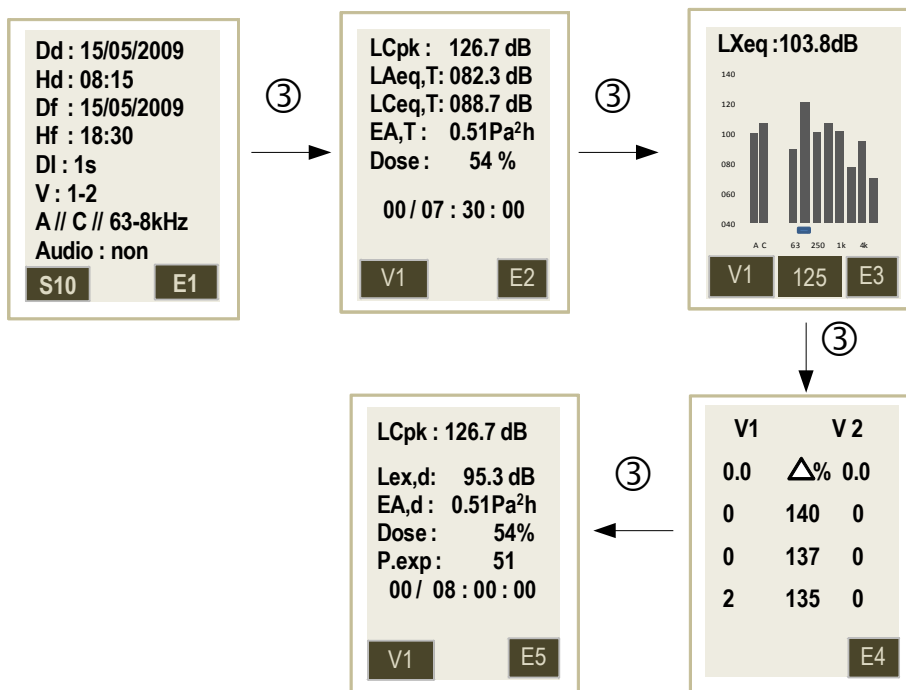

- Press **4** key to back to dataset selection screen.

10.11 Reading in V1 channel mode

- When required dataset number is displayed, press **1** key.
- From main screen, press successively on **3** key to scroll **E1** to **E4** screens.
- Press **4** key to back to dataset selection screen.

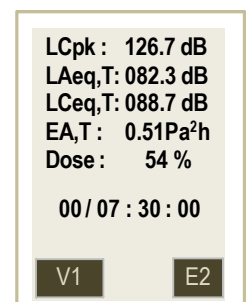

E2 results screen :

- LCpk max on T duration of measurement
- LAeq, LCEq on T duration of measurement
- EA,T noise exposure on T duration of measurement
- Noise dose referenced % at 85 dB during 08h00
- Duration of measurement

E3 : detection screen of overloads and peak level values 135-137-140 dB (see page 37)

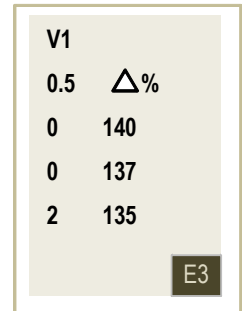

E4 : results displayed on the screen concern the daily exposure level scaled to an exposure of a standardized day of 8 hours from results from T duration of measurement.

This duration T must be representative of the effective duration of the workstation Te.

In this hypothesis, the peak level of noise pressure, noise exposure values and noise dose of the **E4** screen are the same as the values of **E2** screen.

Exposure points : **P.exp** : this number is the equivalent of the hundredth of sound exposure and is used in the simplified method explained by the INRS in its ED6035 document available on the INRS website.

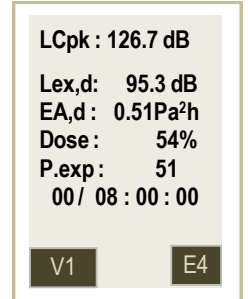

10.12 Reading in V1+V2 channels mode

- When required dataset number is displayed, press **1** key.
- From start screen, press successively on **3** key to scroll **E1** to **E4** screens.
- Press **1** key to go from **V1 channel screen** to **V2 channel screen**.
- Press **4** key to back to general measurement screen.

E2 screen results :

- LCpk max on T duration of measurement
- LAeq, LCEq on T duration of measurement
- EA,T noise exposure on T duration of measurement
- Noise dose referenced % at 85 dB during 08h00
- Duration of measurement

Press **1** key to go from **V1 channel screen** to **V2 channel screen**.

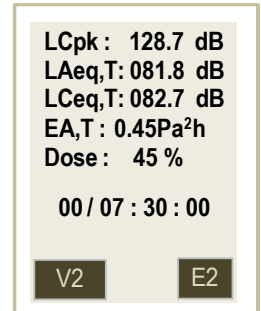
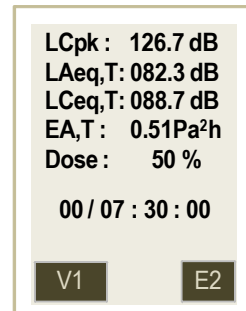

E3 : detection screen of V1 and V2 channels, overloads and peak level values 135-137-140 dB (see page 37)

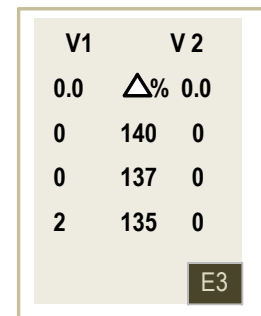

E4 : results displayed on the screen concern the daily exposure level scaled to an exposure of a standardized day of 8 hours from results from T duration of measurement.

This duration T must be representative of the effective duration of the workstation Te.

In this hypothesis, the peak level of noise pressure, noise exposure values and noise dose of the **E4** screen are the same as the values of **E2** screen.

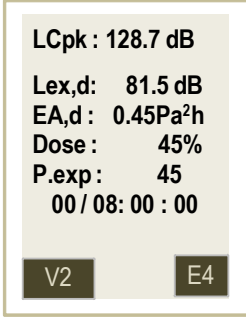
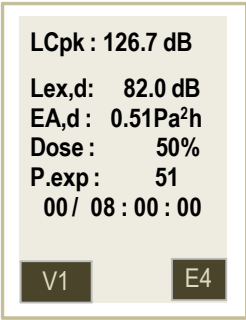

Exposure points : **P.exp** : this number is the equivalent of the hundredth of sound exposure and is used in the simplified method explained by the INRS in its ED6035 document available on the INRS website.

10.13 Reading : V1 channel mode and frequency analysis with filters by octave bands from 63 Hz to 8 kHz

- When required dataset number is displayed, press 1 key.
- From main screen, press successively on 3 key to scroll **E1** to **E5** screens.
- Press 4 key to back to main screen of dataset selection.

E2 results screen :

- LCpk max on T duration of measurement
- LAeq, LCEq on T duration of measurement
- EA,T noise exposure on T duration of measurement
- Noise dose referenced % at 85 dB during 08h00
- Duration of measurement

E3 : screen of frequency analysis from 63 Hz to 8 kHz with graphical display of LXeq,DI

To read values :

- Press successively on 2 key.
The cursor moves *linked to the weighting or the value of filter by octave band and the letter X of LXeq,DI shown inside the pictogram.*
LXeq,DI level is displayed on the top of the screen.

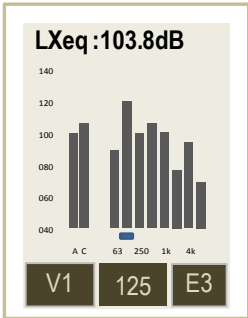
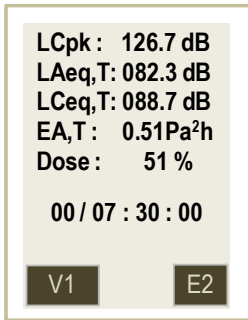

E4 : detection screen of overloads and peak level values 135-137-140 dB (see page 37)

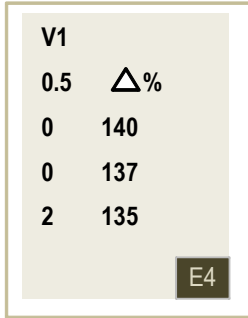

E5 : results displayed on the screen concern the daily exposure level scaled to an exposure of a standardized day of 8 hours from results from T duration of measurement.

This duration T must be representative of the effective duration of the workstation Te.

In this hypothesis, the peak level of noise pressure, noise exposure values and noise dose of the **E5** screen are the same as the values of **E2** screen.

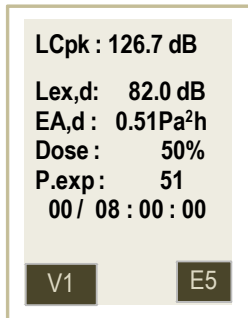

Exposure points : **P.exp** : this number is the equivalent of the hundredth of sound exposure dB and is used in the simplified method explained by the INRS in its ED6035 document available on the INRS website.

10.14 Reading : V1+V2 channels mode and frequency analysis with filters by octave bands from 63 Hz to 8 kHz

- When required dataset number is displayed, press 1 key.
- From main screen, press successively on 3 key to scroll E1 to E5 screens.
- Press 1 key to go from V1 channel screen to V2 channel screen.
- Press 4 key to back to general measurement screen.

E2 screen results :

- LCpk max on T duration of measurement
- LAeq, T, LCEq on T duration of measurement
- EA,T noise exposure on T duration of measurement
- Noise dose referenced % at 85 dB during 08h00
- Duration of measurement

Press 1 key to go from V1 channel screen to V2 channel screen.

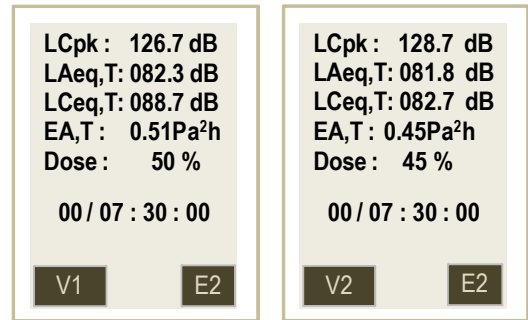

E3 : frequency analysis from 63 Hz to 8 kHz screen with graphical display of LXeq,DI

To read values :

- Press successively on 2 key.
The cursor moves *linked to the weighting or the value of filter by octave band and the letter X of LXeq,DI* shown inside the pictogram. LXeq,DI level is displayed on the top of the screen.

Press 1 key to go from V1 channel screen to V2 channel screen.

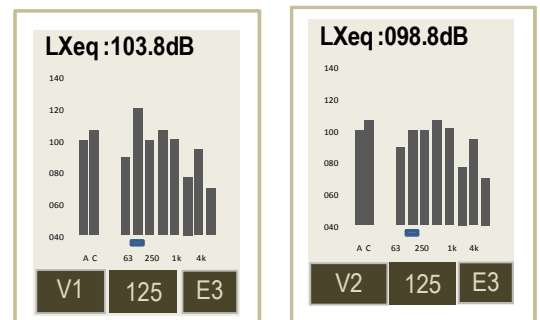

E4 : screen detection of V1 and V2 of overloads and peak level values 135-137-140 dB (see page 37)

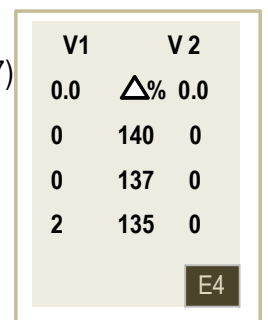

E5 : results displayed on the screen concern the daily exposure level scaled to an exposure of a standardized day of 8 hours from results from T duration of measurement.

This duration T must be representative of the effective duration of the workstation Te.

In this hypothesis, the peak level of noise pressure, noise exposure values and noise dose of the E5 screen are the same as the values of E2 screen.

Press 1 key to go from V1 channel screen to V2 channel screen.

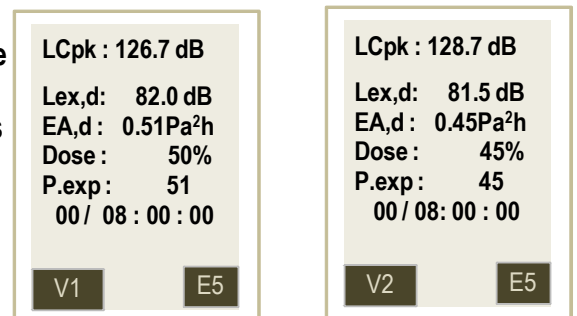

Exposure points : **P_{exp}** : this number is the equivalent of the hundredth of sound exposure and is used in the simplified method explained by the INRS in its ED6035 document available on the INRS website.

10.15 Files transfer

This function allows to transfer data to a computer with a USB cable. **LDS23** or **LDS300** software will have been previously installed on the computer.

- Turn on DS300.
- Link DS300 to PC with a USB cable.
- Press **5** key from start screen.
- Move the cursor on **PC** item with **1** and **2** keys.
- Validate with **3** key.
Screen PC is displayed.
- Press **3** key to pour activate USB connection.

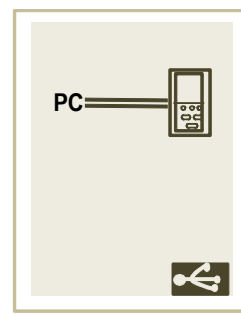
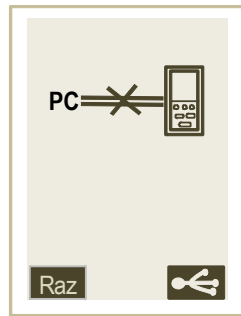
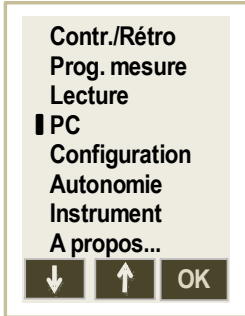

In case of direct connection of the turned off DS300 to the PC, USB connection is activated automatically. PC screen is displayed instantaneously, then the drawn cross on the DS300 screen disappears after a few seconds to confirm the USB connection.

After the transfer, turn off the instrument directly or leave PC screen pressing **4** key.

The instrument is considered by the operating system as a removable disk. Files transfer can be perform according to two ways :

- through LDS23 or LDS300 software (see software user manual)
- directly by activating the files manager of the operating system of the PC (for example : copy/paste function, send to,...) to move files of the removable disk (DS300) to the repertory the directory for the classification of the measurements.

10.16 Delete files

After the storage of the measurement datasets thanks to the transfer to a computer, it is possible to delete the memory of the instrument. Two ways exist :

- through the instrument
- through LDS23 or LDS300 software

Through the DS300 instrument :

- Go to **PC** screen of the DS300.
- Press **1** key (**RAZ**).
RAZ blinks.
- Press again **1** key (**RAZ**) to confirm the deletion of all the data.
Progress bar is displayed.
- Leave the screen with **4** key.

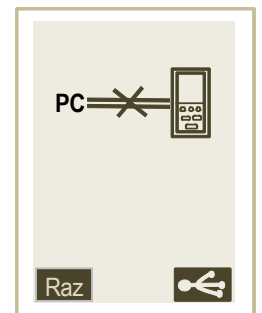

The totality of datasets inside the DS300 instrument will be deleted.

11.1 Instantaneous overload – percentage



- **Instantaneous overload** : in condition of overload of input stages, a pictogram appears. It is displayed fleetingly during measurement and remains displayed during the reading of results.
- **Percentage** : this information can be necessary for a measurement in the medium and long term when the overload indicator is displayed. Its presence does not provide information about the occurrence of overload but the percentage calculation provides a level of alert on measured and displayed levels by the instrument.

11.2 Power supply



This pictogram provides information on the remaining power. In case of low battery, less than one de bar on the pictogram, the instrument stops the measurement and turns off saving the current results.

11.3 Over range measurement

In measurement conditions out of the dynamic range, measured values are not displayed and are et are replaced by signs :

- **+++ , +** : if the value is higher than the top of the range : 40-120 - the top of the range stays opened 60-140
- **--- , -** : if the value is lower than the down of the range : 40 for the range 40-120 or 40-140 and 60 for the range 60-140.

11.4 Detection and counting of peak pressure levels 135-137-140 dB

Detection principle : the detection of peak pressure levels is made at the frequency of instrument sampling, about 23 kHz. So, theoretically, it is possible to detect several thousand of values, maximum 23 000 values per seconds.

During measurement : the instrument records the temporal evolution on an elementary duration programmable from 1 s to 60 s (usually 1 s). it displays and keeps in memory the maximum peak pressure level reached during each duration of elementary integration.

Results : the reading gives for the total measurement duration :

- on the instrument : the maximum peak pressure level reached during the measurement
- with the software : the maximum peak pressure level reached during the measurement and the maximum peak pressure level reached for each duration of elementary integration (usually 1 s).

Counting : only for **40-140dB** and **60-140 dB** measuring ranges. For **40-120 dB** range, counters display 0. The higher value being 123,5 dB peak.

It is limited to the number of elementary periods whom maximum peak pressure level exceeded reference values 135-137-140 dBC (Z).

This principle has the advantage to consider all the values related to the sampling rate (23 000/s possible) and simplifies the results reading and keeps the preventive and regulatory nature of this control.

The example on the right shows that during measurement, the dosimeter had recorded :

- 2 elementary periods whose maximum peak pressure level has exceeded 140 dB
- 4 elementary periods whose maximum peak pressure level has exceeded 137 dB
- 9 elementary periods whose maximum peak pressure level has exceeded 135 dB

V1	
0	△%
2	140
4	137
9	135

E4

So these results show that **during 9 DI elementary periods**, the maximum peak pressure level has exceeded 135 dB, included 4 for 137 dB and 2 for 140 dB.

11.5 Alarms

Analysis criteria of the exposure level are based on the comparisons of obtained results with those defining the lower exposure value, the higher exposure value and the the value of exposure limit. These values are regulatory requirements. The instrument considers these values, mainly for :

- the calculation of results to display
- warn during measurement the person wearing the instrument or the technician in charge of the measurement following.

In this last case, a two-coloured light in the higher part of the housing can be activated (see page 9) for each measurement channel (V1 or V1 and V2).

Orange color : in case of at least one of the following values exceeding :

- $L_{pk} > 135$ dB C or Z
- $L_{Aeq,DI}$ or $L_{Aeq,T} > 80$ dBA
- Dose > 31.62 %

Red color : in case of at least one of the following values exceeding :

- $L_{pk} > 137$ dB C or Z
- $L_{Aeq,DI}$ or $L_{Aeq,T} > 85$ dBA
- Dose > 100 %



11.6 Auto Off

This function allows to save battery in case of unwanted turning on or forgetting to stop the instrument. It is activated after 15 minutes, if no measurement or calibration launching is performed.

It is active by default, but can be deactivated (see page 10).

11.7 LCD locking

The locking of the instrument display during measurement can be useful according to the situation.

In active locking mode, the LCD screen turns off 60 seconds after the measurement launching in storage mode. To reactivate the LCD screen, press a key and enter a code.

In inactive locking mode, the LCD screen remains always on.

To confirm the reactivation of the LCD screen, an authorization number must be fill in :

- Move the cursor in inverted video on the number **0000** in the middle of the screen.
- Select successively the numbers with **2** and **3** keys.
- Move the cursor on the **LCD** arrow after the last number.
- Press **1** key (LCD) to validate.

LCD screen is reactivated.

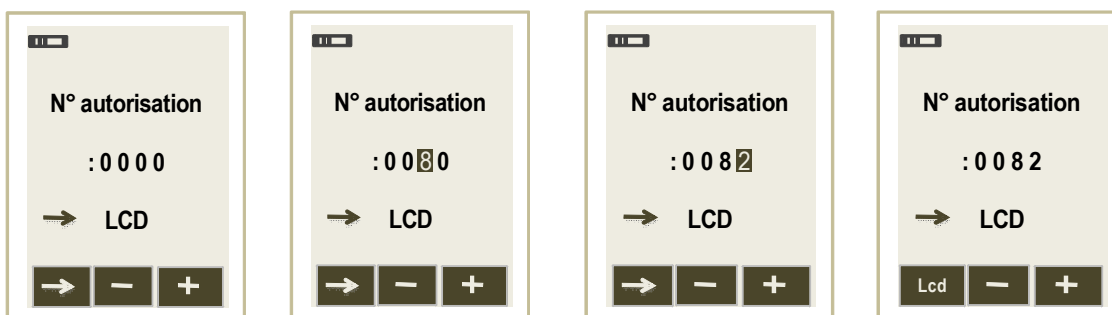

IMPORTANT : reactivation number is **0082**.

Note : it is possible to customize the authorization code. For that, please see **LDS300** software user manual.

11.8 Stop locking – waiting mode

The locking of the measurement stop or of the waiting mode (delayed start) can be useful according to the situation. In active locking mode, the measurement stop in storage mode and the leaving of the waiting mode in delayed start, are impossible. To reactivate these possibilities, enter a code (see previous page).

In inactive locking mode, the measurement stop and the leaving of the waiting mode in delayed start become become immediately accessible.

12.1 Care

The dosimeter conception allows a reduced maintenance which consists in changing batteries and cleaning the instrument with a slightly cloth. A particular attention must be paid to the microphone sensor, which is the element the most sensitive of the metrological chain.

12.2 Regular checking

Like most measuring instruments, it is strongly recommended to regularly control and calibrate DS300 instrument. Return to the manufacturer each year will provide necessary metrological traceability.

12.3 Load the battery

Use a USB power adaptor which serves as a charger and ensure that the instrument is turned off.

It is also possible to connect the instrument to a USB connection of an operating computer. The battery will load according to the available power at the USB output, about 500 mA.

A 5 hours duration is necessary to get a full charge. The light situated at the top of the instrument informs as follows :

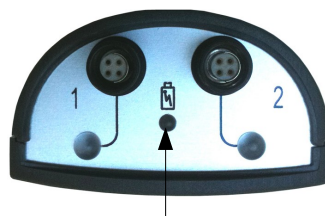

Battery loading light

- **Red light** : load in progress
 - **Green light** : completed charge
 - **Orange light** :
 - the instrument stayed on during loading. Turn off the instrument.
- or
- there is a power supply problem : return the device and its accessories to the manufacturer.

13 Preparing for measurement

To perform a good measurement, several parameters are to be considered and mainly the methodology that is deduced from the general situation. After having selected the appropriate method , it is necessary to take a few measurement precautions to get correct and significant results. Consider at least the following items :

13.1 Preparing the instrument

- Check the operating autonomy : memory, audio recording capacity and battery. Erase the memory and load the battery if necessary.
- Set the delayed or repetitive delayed start according to the selected method.
- Set the measurement parameters (by keypad or with the LDS300 software)

13.1.1 Channel V1 measurement only

- Position imperatively the microphone with black sleeve and its extension on **channel 1**.

Important : the **D-MB** microphone must be connected exclusively on **V1 connection** for a sound level meter use.



13.1.2 Measurement with V1 and V2 channels

- Position imperatively the two microphones and their extension as follow :
 - microphone with black sleeve on **V1 channel**
 - microphone with blue sleeve on **V2 channel**

In case of inversion or incompatibility with the programming, a warning screen is displayed preventing the measurement launching : rectify connections or programming.

Important : do not forget to calibrate the two channels according to the procedure described in the calibration chapter (see page 13).

13.1.3 Wearing the instrument

According to the observed station and to the material conditions, the instrument can be worn :

- on the person belt : use the protection cover supplied with the instrument
- in the upper pocket of the protection cloth (scrubs ...) : clip the instrument in the pocket. Do not hesitate to move away the microphone from clothes thanks to its flexible neck.



13.1.4 Fixing the microphone

The microphone is a sensitive element, it must be positioned according to NF EN ISO 9612 : may 2009 standard recommendation.

The microphone must be mounted at about **0.04 m** above the shoulder and at **0.10 m** of the canal entrance of the most exposed ear. The cable must be slipped inside the cloth or firmly maintained with an adhesive tape in order to avoid any frictions that could disrupt measurement.

Le microphone can be fixed with two different ways :

- **with the mechanical module.** This module is composed by an attachment clamp with circular base to maintain on the cloth or other accessory worn by the person (helmet, scrubs,...) and a "fork" plug of 4 cm length to clip the microphone.

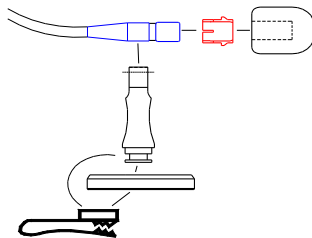

Recommendations : pinch the cable through the cable guide. It minimizes the movement of the cable around the microphone.

- **With the magnetic module** which contains an imitation skin plate in which is put a magnet and a "fork" plug of 4 cm length to clip the microphone integrating in its base a magnet. The plate is put under the cloth at the level of the shoulder or any other part of the cloth. The "fork" plug becomes fixed by magnetic attraction straight of the plate over the cloth.

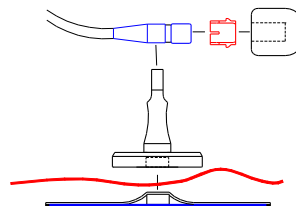

This is a magnetic fixing plate, do not use it on people with pacemaker or equivalent.

13.1.5 Using the windscreen

The windscreen is necessary to minimize the air-current effects. It comes on the the microphone with its anti-slide safety clip. In case of wear, only the foam part can be replaced :

- To remove the windscreen : take it between the thumb and the forefinger and pull hard.
- In case of calibration, remove the windscreen.



14.1 Standards

The instrument meets the following standards :

- NF EN 61252 (2002) / IEC CEI 61252 (2002) / IEC CEI 61672 (2003) / IEC CEI 61260 – 1995 / A1-2001
- NF EN 61000-6-1 / NF EN 61000-6-2 / NF EN 61000-6-3 / NF EN 61000-6-4 (2001)

14.2 Metrology

Features	Leq and Lp channels	Peak channel
Accuracy	Class 2	Class 2
Dynamic range V1 only	40-140 dB	93-143 dB
Dynamic range V1 and V2	40-120 or 60-140 dB	73-123 or 93-143 dB
Frequency weightings	A and C	C or Z
Filters	8 filters by octave band from 63 Hz to 8 kHz	
Values	LAF, LAS, max, min, LAeq, LCeq, LXeq, max, min, Lex, d, EAT, DOSE	LCpk, LZpk
Simultaneous measurement mode	LAeq-LCeq-LXeq (63 Hz-8 kHz)	LCpk, LZpk
Duration of LXeq integration	From 1s to 60 s (step of 1s)	
Noise pressure sampling	24 kHz	24 kHz
Detection and peaks counting		135 dB – 137 dB – 140 dB
Memory module	Integrated type Micro SD 2 Go – Data download by USB cable	
Storage capacity	99 event timers (work station)	
Clock accuracy	Better than 0,01 %	
Microphone	Type electret – diameter : 9.5 mm (3/8") – 15 mV/Pa	
Audio recording (optional)	On micro SD card 2 GO – Maximum duration : 01H00 – Format : 11 kHz / 8 bits -16 bits	
Power supply – Battery life	Internal Li-ion battery rechargeable – Battery life > 28 hours and according to configuration	
Operation	From -10 °C to +50 °C / from 650 hPa to 1080 hPa / from 0 to 95 %HR	
Storage	From 0 to +50 °C	

14.3 Charger for battery

- Type : universal main adapter
- Output plug : format USB
- Input : 100-240 VAC – 50/60 Hz
- Output : 5V DC 1000 mA (5 VA max)

14.4 Dimensions – Weight

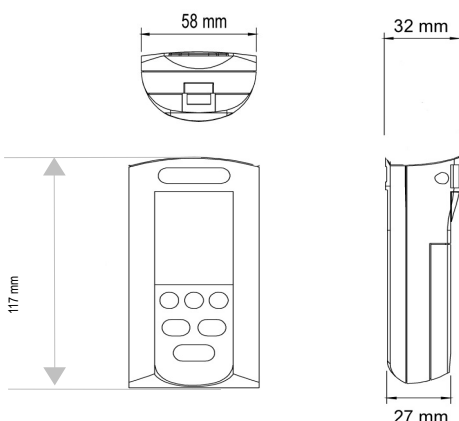

Cable extension for microphone : 1.25 m
Weight with battery : 200 grs

14.5 Audio recording capacity

The audio recording brings information to identify sources and correspondence with the recorded noise levels. It is characterized by a sampling rate and an accuracy expressed in number of bit. So a recording capacity is deduced :

Sampling	Pre and post recording	Accuracy	Recording capacity (HH:MM:SS)
12 kHz	4s	16 bits	00:50:00

14.6 Battery life

The battery life directly depends on the retained measurement mode and ambient conditions.

Reminder :

- V1 channel without frequency analysis with or without audio
- V1 + V2 channels without frequency analysis with or without audio
- V1 channel with frequency analysis with or without audio
- V1 + V2 channels with frequency analysis with or without audio

Mode					Battery life / HH
V1	V2	A/C//LpK	1/1 oct	Audio	
X		X			28
X		X		X	20
X		X	X		20
X		X	X	X	20
X	X	X			28
X	X	X		X	20
X	X	X	X		20
X	X	X	X	X	20

Reference temperature : 20 °C

14.7 Delivery and packaging

- **DS300** instrument with microphone and 1.25 m extension
- Carrying case with protective foam
- Adapter ring for acoustic calibrator
- Fixing kit for microphone
- Protective cover to wear on belt
- Main charger with USB plug with cable
- Calibration certificate
- CD-rom with **LDS23** software user manuals of the instrument and software

14.8 Optional and accessories

Microphone V2 channel with fixing kit : **D-M2**

Direct microphone : **D-MB**

Audio recording on threshold : **D-EA**

Processing software : **LDS300**

Carrying case for 5 instruments : **D-V5**

Charger and transfer station for 5 instrument : **D-S5**

Acoustic calibrator 94 dB/1000 Hz : **CAL200**



Once returned to KIMO, required waste collection will be assured in the respect of the environment in accordance to 2002/96/CE guidelines relating to WEEE.

www.kimo.fr

EXPORT DEPARTMENT
Boulevard de Beaubourg - Emerainville - BP 48
77312 MARNE LA VALLEE CEDEX 2
Tel : + 33.1.60.06.69.25 - Fax : + 33.1.60.06.69.29

